

# UC Davis

## Information Center for the Environment Publications

### Title

Urban Growth in California: Projecting growth in California (2000-2050) under six alternative policy scenarios and assessing impacts to future dispersal corridors, fire threats and climate-sensitive agriculture. Urban Growth in California: Projecting...

### Permalink

<https://escholarship.org/uc/item/91g0c2d3>

### Authors

Thorne, James H  
Bjorkman, Jacquelyn  
Roth, Nathaneil

### Publication Date

2012-07-12

### Copyright Information

This work is made available under the terms of a Creative Commons Attribution License, available at <https://creativecommons.org/licenses/by/4.0/>

Peer reviewed

# **URBAN GROWTH IN CALIFORNIA**

## **Projecting Growth in California (2000–2050) Under Six Alternative Policy Scenarios and Assessing Impacts to Future Dispersal Corridors, Fire Threats, and Climate-Sensitive Agriculture**

A White Paper from the California Energy Commission's California Climate Change Center

Prepared for: California Energy Commission

Prepared by: University of California, Davis



JULY 2012

CEC-500-2012-009

James H. Thorne  
Jacquelyn Bjorkman  
Nathaniel Roth

University of California Davis  
1 Shields Ave.  
Davis, CA 95616



### **DISCLAIMER**

This paper was prepared as the result of work sponsored by the California Energy Commission. It does not necessarily represent the views of the Energy Commission, its employees or the State of California. The Energy Commission, the State of California, its employees, contractors and subcontractors make no warrant, express or implied, and assume no legal liability for the information in this paper; nor does any party represent that the uses of this information will not infringe upon privately owned rights. This paper has not been approved or disapproved by the California Energy Commission nor has the California Energy Commission passed upon the accuracy or adequacy of the information in this paper.

## **ACKNOWLEDGEMENTS**

We would like to thank the Information Center for the Environment co-directors, Dr. Jim Quinn and Dr. Karen Beardsley, ULTRANS director Mike McCoy, and Robert Johnston, professor emeritus for logistical and work space support. Alan and Lorraine Flint of the United States Geological Survey and Jim Thorne and Ryan Boynton from the University of California Davis provided downscaling of climate data for climate change impacts. Lee Hannah and Patrick R. Roehrdanz provided Network Flow Model outputs for use in the Biodiversity UPlan Scenario. Louise Jackson, Van R. Haden, Stephen Wheeler, and Allan Hollander provided Agricultural Vulnerability surface layers for impact assessment. Meg Krawchuk and Max Moritz provided Mean Fire Return Interval data for wildfire impact analysis. Benjamin Bryant and Anthony Westerling provided future wildfire probability and expected losses.

## ABSTRACT

This paper documents the development of land use models that represent different urban growth policy scenarios for California, a contribution to the Public Interest Energy Research (PIER) Climate Vulnerability and Assessment Project of 2010–2011. The research team produced six UPlan model runs that portray the following policies as footprint scenarios to 2050: Business as Usual, Smart Growth, Fire Adaptation, Infill, Conservation of Projected Connectivity for Plant Movement under Climate Change, and Conservation of Vulnerable Agricultural Lands. This paper compares the outputs from these six scenarios on outputs from three other PIER vulnerability studies: biodiversity, fire return interval, and agricultural sensitivity. While not directly targeting any conservation or agricultural objective, the Infill scenario preserved more open space for other use than any of the other scenarios. The results suggest that combining Infill objectives with other open space goals will produce better conservation goals for those objectives than merely directing growth away from landscape elements of conservation interest.

**Keywords:** Urban growth model, Land Use, policy scenarios, redevelopment, UPlan

Please use the following citation for this paper:

Thorne, James, Jacquelyn Bjorkman, and Nathaniel Roth (University of California, Davis). 2012. *Urban Growth in California: Projecting Growth in California (2000–2050) Under Six Alternative Policy Scenarios and Assessing Impacts to Future Dispersal Corridors, Fire Threats and Climate-Sensitive Agriculture*. California Energy Commission. Publication number: CEC-500-2012-009.

# TABLE OF CONTENTS

<b>Acknowledgements</b> .....	<b>i</b>
<b>ABSTRACT</b> .....	<b>ii</b>
<b>TABLE OF CONTENTS</b> .....	<b>iii</b>
<b>LIST OF TABLES</b> .....	<b>iv</b>
<b>LIST OF FIGURES</b> .....	<b>v</b>
<b>Section1: UPlan</b> .....	<b>1</b>
1.1 Introduction .....	1
1.2 UPlan Background .....	2
1.2.1 Attractions to Development .....	3
1.2.2 Discouragements or Exclusions to Development.....	6
1.2.3 Allocation of Future Growth .....	8
1.3 Model Inputs.....	12
1.3.1 Demographic Data .....	12
1.3.2 Spatial Data .....	14
1.4Outputs.....	15
1.4.1 Spatial Output .....	15
1.4.2 Tabular Outputs .....	17
<b>Section 2: Scenarios</b> .....	<b>21</b>
2.1 Base Case .....	21
2.2 Smart Growth .....	23
2.3 Fire Threat Avoidance.....	25
2.4 Infill Scenario .....	28
2.5 Biodiversity Scenario .....	33
2.6 Agriculture Scenario.....	35
<b>Section 3: Performance of Scenarios on Additional Impact Measurements</b> .....	<b>37</b>
3.1 Agricultural Vulnerability .....	37
3.1.1 Climate Vulnerability .....	38
3.1.2 Crop Vulnerability .....	39

3.1.3 Land Use Vulnerability .....	42
3.2 Biodiversity .....	44
3.3 Wildfire.....	49
3.3.1 Wildfire Probability .....	49
3.3.2 Wildfire Risk .....	55
<b>Section 4: Discussion and Summary .....</b>	<b>56</b>
<b>References .....</b>	<b>59</b>
<b>Glossary .....</b>	<b>61</b>
<b>Appendix A: Conversion Formulas in UPlan.....</b>	<b>62</b>
<b>Appendix B: Demographic Inputs for UPlan Runs.....</b>	<b>63</b>
<b>Appendix C: CTPP to UPlan Employment Classes Crosswalk.....</b>	<b>63</b>
<b>Appendix D: UPlan Model GIS Layers and Weights for Attractions, Discouragements, and Masks.....</b>	<b>63</b>
<b>Appendix E: Infill Scenario Zonal Summaries by County.....</b>	<b>63</b>

## LIST OF TABLES

Table 1: UPlan Land Use Types Used in Each Scenario .....	3
Table 2: Attraction Layers Used in Model, along with the Affected Land Use Group and Scenario .....	4
Table 3: Attraction Layers and Associated Buffer Distances and Weights.....	5
Table 4: Model Input Discouragement Layers, with Buffer Distances, Weights, and Scenarios....	7
Table 5: UPlan Land Use Type and General Plan Crosswalk.....	9
Table 6: Raster Cell Value to UPlan Land Use Type Crosswalk .....	15
Table 7: Guide for Adding Additional General Plan Categories to Available Development Space .....	17
Table 8: UPlan Report Showing the Results for a Ventura County Run.....	18
Table 9: General Plan Codes for Use with the UPlan Report.....	20
Table 10: Modifications to Residential Land Use Proportions for Smart Growth Scenario .....	24
Table 11: Average Square Footage per Employee by Commercial Class.....	30

Table 12: Inputs for Second Run of Infill Scenario .....	31
Table 13: Table Showing the Different Combinations of Overlap Between the Climate Scenarios and Conservation Targets and their Corresponding Discouragement Weights. The highest weights occur when both climate scenarios predict a conservation target for a given climate model. ....	34
Table 14: The Network Flow Model Categories .....	45
Table 15: The Number of Acres of New Residential Development that Coincide with Each Network Flow Model Category for 2050.....	47
Table 16: The Number of Acres of New Residential Development that Coincide with Each Network Flow Model Category by 2080.....	49

## **LIST OF FIGURES**

Figure 1: Attraction Grid for Sutter County Showing the Highest Values Concentrated Around City Boundaries, Roads, and Highway Ramps .....	6
Figure 2: General Plan for Yolo County.....	10
Figure 3: Allocation by Grid Cell. A: the amount of space needed is determined by the demographic inputs to the model. B: the General Plan grid shows how each cell is designated one General Plan type. While each cell can only have one General Plan type, the user can allow multiple UPlan Land Use Classes to each General Plan type. C: the net attraction layer shows the value of each cell once all of the attractions and discouragers have been added together. D: the allocation of each cell is performed in sequence and according to the general plan and highest net attraction value. ....	11
Figure 4: Example of Three Buildings with a FAR = 1).....	14
Figure 5: Legend for UPlan Land Use Output.....	16
Figure 6: Statewide UPlan Output, Base Case Scenario .....	22
Figure 7: Statewide UPlan Output, Ventura County, Base Case Scenario.....	23
Figure 8: Statewide UPlan Output, Smart Growth Scenario .....	24
Figure 9: Statewide UPlan Output, Ventura County, Smart Growth Scenario.....	25
Figure 10: FRAP Fire Threat Map. These different threat classes denote the different discourager weights for the Fire Threat Avoidance Scenario. ....	26
Figure 11: Comparison of the Area (acres) of Residential and Commercial Growth Over Fire Threat Areas, Base Case and Fire Threat Avoidance Scenarios .....	27
Figure 12: A Close-up of Santa Barbara County, one of the Counties with a Substantial Amount of Area Threatened by Fire. The First Map Shows the New Residential Growth from the Base Case Scenario, Which Overlaps Significantly the Areas of Fire Threat. ....	28



Figure 13: Densification Process of Residential Classes for a Sample County (San Diego County)	30
Figure 14: Infill Scenario Example for Alameda County. 612,599 new residents are projected for the year 2050. The first run places 612,463 residents within the urban extent, displacing 403,665. The displaced residents are added in the second run, just outside the existing urban extent.....	32
Figure 15: Comparison of the Final Outputs for Each Scenario for Fresno County. A. Base Case Scenario. B. Smart Growth Scenario. C. Infill Scenario. D. Chart Showing Total Amount of Acres of Development for Each Scenario. ....	33
Figure 16: The Central Coast of California Showing the Biodiversity Target Areas and the Biodiversity UPlan Model Output.....	35
Figure 17: Crop Sensitivity Index .....	36
Figure 18: Kern County, showing the Agricultural Scenario UPlan Output and the Crop Sensitivity Areas.....	37
Figure 19: Climate Vulnerability Surface.....	38
Figure 20: The Number of Acres of New Residential Development within Each Climate Vulnerability Class.....	39
Figure 21: Crop Vulnerability Surface.....	40
Figure 22: The Number of Acres of New Residential Development Within Each Crop Vulnerability Class.....	41
Figure 23: Zonal Summary of the Number of Acres of Residential Development in Each Scenario with the Clipped Crop Vulnerability Layer .....	42
Figure 24: Land Use Vulnerability Surface.....	43
Figure 25: The Number of Acres of New Residential Development within Each Land Use Vulnerability Class.....	44
Figure 26: The Number of Households and Acres in Each UPlan Scenario within Each Climate Scenario and Protection Value .....	46
Figure 27: The Number of Households and Acres in Each UPlan Scenario within Each Climate Scenario and Protection Value for the year 2080.....	48
Figure 28: Mean Fire Return Interval (Years). The Areas in Dark Brown Show Where Fire is Predicted to Occur at Least Once in the Next 75 Years. The Conditions of the PCM Climate Scenario Show an Overall Higher Risk for Fire in the State. ....	50
Figure 29: The Number of Acres of New Residential Development Within Each Scenario that Coincide with Areas of Predicted Fire, Under GFDL A2 and PCM A2 Climate Conditions, 2040-2069 .....	51
Figure 30: The Number of New Residents by 2050 that Are Projected to Live within Each Fire Return Interval Zone .....	53

Figure 31: The Number of Acres of New Residential Development within Each Scenario That Coincide with Areas of Predicted Fire, Under GFDL A2 and PCM A2 Climate Conditions, 2070–2099 ..... 54

Figure 32: Zonal Summary of the Number of Acres of Residential Development in Each Scenario with the FRAP Fire Threat Layer ..... 55

Unless otherwise noted, all tables and figures are provided by the authors.

# Section1: UPlan

## 1.1 Introduction

The California Energy Commission Public Interest Energy Research (PIER) 2010 Vulnerability and Adaption (V&A) study includes generation of six policy-based urban growth model outputs that will simulate the spatial patterns of land use in California. This paper describes the development and projected impacts of these scenarios to future fire probability, future plant species dispersal needs, and climate-sensitive agriculture. The land use model (UPlan) outputs are statewide compilations of county-level model runs that project urban and rural growth to the year 2050, using a standard set of demographic and geographic inputs, representing attractors and discouragers under current conditions. Demographic inputs are based on data from the Public Policy Institute of California (PPIC), U.S. Census, California Department of Finance, and InfoUSA. Each scenario has multiple land use types into which the population is spatially assigned: four to seven residential types that vary by density, and three employment types (high- and low-density commercial and industrial). Geographic inputs include road networks, existing urban, county-level zoning maps, and other map-based elements. These are used jointly to create an attraction or discouragement value for every grid cell of the region that might be developed. UPlan then assigns growth to the cells for each class of development, sequentially. The spatial outputs can then be used to assess how future growth may affect resources.

Scenario 1 represents a “business-as-usual” policy toward development. The percentages of people living in each residential density class reflect the current patterns in California, with more of the population living in the lower-density residential classes.

Scenario 2 represents a “smart-growth” policy toward development, with more of the population residing in high-density living space. Growth in this scenario is compact, and is concentrated more around existing towns and cities.

Scenario 3 corresponds to a “wildfire-avoidance” policy toward development, where areas threatened by wildfires are deterred from developing.

Scenario 4 builds on the smart-growth scenario and adds a “redevelopment” component to compact development even further.

Scenario 5 incorporates a plant habitat conservation model, to prioritize “biodiversity” among native taxa in California.

Scenario 6 features a policy toward avoiding areas of “vulnerable agriculture” in California, based on both climate sensitivity and crop diversity.

## 1.2 UPlan Background

UPlan is a geographic information system (GIS) application that functions in coordination with Esri's ArcGIS to project future land use patterns.

The UPlan model works based on the following assumptions:

- That population growth can be converted into demand for land use by applying conversion factors to employment and households.
- That new urban expansion will conform to city and county general plans.
- Cells have different attraction weights because of accessibility to transportation and infrastructure.
- Some cells, such as lakes and streams, will not be developed. Other cells, such as sensitive habitats and floodplains, will discourage new development, and can be assigned discouragement values.

Land consumption by new land use type is calculated using user-specified demographic and land use factors that are converted to acres of land consumed in each urban structure class. For the purposes of this paper, the terms *land use* and *urban growth* are used interchangeably, although the outputs from the model are units of development that are not equivalent to a broader set of activities that could be identified as land use. The model parameterization starts with population projections for counties or an entire region. To determine acres needed for future housing, the user specifies persons per household, percent of households in each density class, and average parcel size for each density class. A similar conversion, in which workers per household, percent of workers in each employment class, and average area per worker (in square feet and acres) are the inputs, is used to determine acres of land consumed for industry and commerce. The model produces a table of acres demanded for each land use category from which the model operates its allocation routine. If the total available acres for new development are smaller than the total acres needed for the projection year, a warning message will appear to catch the user's attention when a model run ends.

While users can define the land use types for the model, the PIER V&A statewide scenarios used a set of default land use types based on population density. Not all land use types were used for some scenarios. Table 1 shows the land use types selected for each scenario. The formulas that convert the population into acres needed are listed in Appendix A. Details of the inputs that were used in the statewide model are described in the following section.

**Table 1: UPlan Land Use Types Used in Each Scenario**

<b>UPlan Land Use Name</b>	<b>Description/Average Density</b>	<b>Scenarios Where Used</b>
Ind	Industry 613 sq.ft./employee .23 FAR (Floor-Area-Ratio)	All
CH	High-density Commercial 498 sq. ft./employee .35 FAR (Floor-Area-Ratio)	All
CL	Low-density Commercial	All
R50	Residential 50 (50 units/acre)	Smart Growth, Infill Only
R20	Residential 20 (20 units/acre)	All
R10	Residential 10 (10 units/acre)	Smart Growth, Infill Only
R5	Residential 5 (5 units/acre)	All
R1	Residential 1 (1 unit/acre)	All
R.5	Residential .5 (2 acre lots)	Smart Growth, Infill Only
R.1	Residential .1 (10 acre lots)	All

\*The commercial and industrial classes for the Infill Scenario reduced the square footage/employee by 50 percent.

### **1.2.1 Attractions to Development**

It is assumed that development occurs in areas that are attractive due to their proximity to existing urban areas and transportation facilities, such as freeway ramps (Befort et al. 1988; LaGro and DeGloria 1992; Alig et al. 2003; Herold et al. 2003; Foreman 2008; White et al. 2009; Johnston et al. 2009). It is also assumed that the closer a vacant property is to an attraction, the more likely it will be developed in the future. For example, a property that is a quarter mile away from existing development (or any attraction for that matter) is more desirable than one that is a mile away from the same location. The attraction layers do not change through time, but are assumed to be static.

Following these assumptions, each development attraction (described below) is surrounded by user-specified buffers, or straightline distances radiating from the exterior boundary of each attraction layer. The user can designate the number and size of the buffer intervals and assign an attractiveness weight to each buffer. Buffer weights for attractions and discouragements (explained in the following section) were chosen based on their relative importance to other attraction and discouragement layers. For example, for the area surrounding highways between 0 and 500 meters, a value of 20 was used for an attraction weight. The area immediately surrounding major roads (between 0 and 500 meters) was assumed to be slightly less attractive than highways to new growth, and was therefore given a value of 14 (Table 2). Buffer specifications are applied to each of the attraction grids, and then the grids are overlaid and added together to make a composite attraction grid.

The attractions are buffered and weighted by land use groups. There are five groups:

1. Industrial
2. High-Density Commercial and Low-Density Commercial

3. High-Density Residential (R50)
4. Medium-Density Residential (R5, R10 and R20)
5. Low-Density Residential (R1, R.5, and R.1)

The attractions for one land use group are not necessarily the same as those for another group, and the attractions for one land use group will have no impacts on the allocation of other land use types, except where base model operations are changed to simulate specific policies.

The spatial layers used as attractors are listed below, along with the effected land use groups and scenarios. Not every spatial layer is used as an attractor for every land use group. For example, census blocks with positive growth between 1990 and 2000 are used as attractors for residential land use classes in UPlan, but not for commercial or industrial land use classes.

**Table 2: Attraction Layers Used in Model, along with the Affected Land Use Group and Scenario**

Attraction Layer	Land Use Group	Scenario
Highways	All	All
Major Roads	All	All
Minor Roads	Residential and Commercial	All
City Boundaries	All	All
Ramps	All	All
Blocks with Growth	Residential	All
Amtrak Stations	High- and Medium-Density Residential, Commercial and Industrial	Infill only
Rail Lines	High- and Medium-Density Residential, Commercial and Industrial	Infill only
Transit Stops	High- and Medium-Density Residential, Commercial and Industrial	Infill only
Existing Urban	All	Infill only

Each buffer layer has a set of weights that decrease with increasing distance from the outside boundary of the layer. The buffer layers, weights, and distances are detailed in Table 3 below.

**Table 3: Attraction Layers and Associated Buffer Distances and Weights**

<b>Attraction Layer</b>	<b>Buffer Number</b>	<b>Buffer Distance (meters from layer boundary)</b>	<b>Weight</b>
Highway	1	0–500	20
Highway	2	500–1000	15
Highway	3	1000–3000	10
Highway	4	3000–5000	5
Highway Ramps	1	0–500	20
Highway Ramps	2	500–1000	15
Highway Ramps	3	1000–3000	10
Highway Ramps	4	3000–5000	5
Highway Ramps	5	5000–8000	2
Major Roads	1	0–500	14
Major Roads	2	500–1000	8
Major Roads	3	1000–3000	4
Minor Roads	1	0–500	12
Minor Roads	2	500–1000	6
Minor Roads	3	1000–3000	2
City Boundaries*	1	0–0	60
City Boundaries*	2	0–500	50
City Boundaries*	3	500–1000	40
City Boundaries*	4	1000–3000	30
City Boundaries*	5	3000–5000	20
Blocks with Growth	1	0–0	30
Amtrak Stations	1	0–500	20
Amtrak Stations	2	500–1000	15
Amtrak Stations	3	1000–3000	10
Amtrak Stations	4	3000–5000	5
Rail Lines	1	0–500	20
Rail Lines	2	500–1000	15
Rail Lines	3	1000–3000	10
Rail Lines	4	3000–5000	5
Transit Stops	1	0–500	20
Transit Stops	2	500–1000	15
Transit Stops	3	1000–3000	10
Transit Stops	4	3000–5000	5
Existing Urban	1	0–0	120
Existing Urban	2	0–500	100
Existing Urban	3	500–1000	80
Existing Urban	4	1000–3000	60
Existing Urban	5	3000–5000	40

\*The weights associated with the City Boundaries layer were doubled for both the Smart Growth and the Infill Scenarios.

The composite attraction grid is a single grid of the sum of the weights specified for each individual attraction grid. Each cell in this grid has a value resulting from the summation. Grid cells with the highest value are considered the most attractive areas for development (Figure 1).

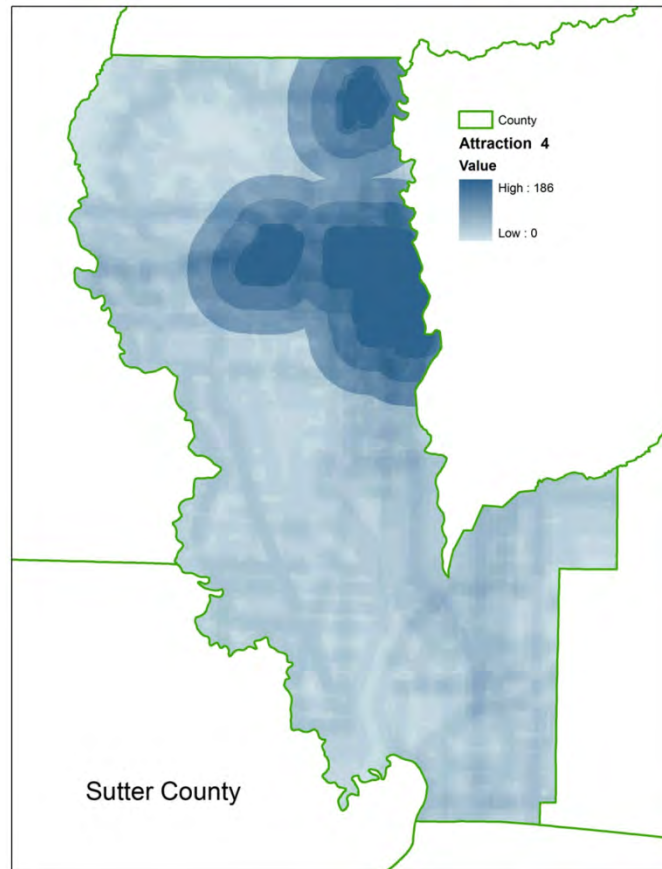

**Figure 1: Attraction Grid for Sutter County Showing the Highest Values Concentrated Around City Boundaries, Roads, and Highway Ramps**

This map illustrates the accumulative attraction values for Sutter County for the commercial growth (high-density and low-density) buffer class. This includes highways, ramps, major roads, minor roads, and city boundaries, but not census blocks with growth, which is an attraction layer for residential growth.

### **1.2.2 Discouragements or Exclusions to Development**

In every scenario, there are areas called *exclusions* where development cannot occur. Exclusions include features such as lakes and rivers, public open space, existing built-out urban areas, and other such features. Once the user decides which features are to be excluded, the model adds the various exclusion grids to generate a *mask*. The composite mask grid is the union of the individual exclusion grids. In this case, however, grid cell values are not important; rather, simply having a value makes a cell part of the mask.

Some features, such as habitats, 100-year floodplains, and farmland might be developable at a high price. These features are called *discouragements*. Any feature that will discourage development can be used as discouragement. Like attractors, the user can specify the range of



buffers and weights, indicating to what extent the development will be discouraged. The weight is a positive number which the model will subtract from the attraction layer to form a final attraction grid (Table 4).

**Table 4: Model Input Discouragement Layers, with Buffer Distances, Weights, and Scenarios**

Discouragement Layer	Buffer Number	Buffer Distance (meters from layer boundary)	Weight	Scenarios
Natural Habitats	1	0-0	10	All
100-year Floodplains	1	0-0	10	All
Wetlands	1	0-0	10	All
Vernal Pools	1	0-0	10	All
Extreme Fire Threat	1	0-0	60	Fire Threat Avoidance only
Very High Fire Threat	1	0-0	40	Fire Threat Avoidance only
High Fire Threat	1	0-0	20	Fire Threat Avoidance only
High Crop Sensitivity	1	0-0	50	Agriculture only
Moderately High Crop Sensitivity	1	0-0	60	Agriculture only

\*Biodiversity Scenario discouragement layers and associated buffer data are described in Section 2.5.

### 1.2.2.3 Existing Urban

The area denoting existing urban development is used as a mask or exclusion to new development in all of the UPlan model scenarios (although it is allowed in one of the two model runs for the Infill Scenario; see Section 2.4 for further explanation). It is also assumed that all of the California residents in the year 2000 reside within the existing urban layer. The spatial layer we chose for existing urban for most of the county model runs is the 2007 California Augmented Multisource Landcover Map (CAML) (Hollander 2010). This layer combines multiple sources of landcover spatial datasets into one raster data layer, with 62 landcover classes and a 100-meter resolution. The “urban” landcover class in CAML is a compilation of the 2002 Multi-source Land Cover dataset produced by the California Department of Forestry and Fire Protection (FRAP), the Department of Conservation Farmland Mapping and Monitoring Program (FMMP), and the 2001 National Land Cover Dataset (NLCD; Fry et al. 2009). These three sources use different methods for creating urban boundaries.

The FRAP Multi-source Land Cover dataset is a 100-meter resolution raster layer which merges multiple data sources in an effort to capture wetlands, riparian areas, and other phenomenon typically included within other classes of statewide mapping efforts. For the “urban” category, FRAP evaluated the number of housing units per block group from the U.S. Census, and the United States Geological Survey (USGS) land use areas were extracted using the commercial, transportation, and industrial classes. If data sources differed in their classifications, an order of precedence was used when merging the multiple datasets. Urban areas took precedence over all other sources except USGS statewide water bodies (FRAP 2002).

The FMMP layer is a vector-based dataset that focuses on different agricultural lands classified by soil quality. They include an “urban and built-up” land category that includes areas

occupied by structures with a building density of 1 unit to 1.5 acres or greater. This can include households, commercial and industrial buildings, rail yards, and water control structures.

The NLCD layer characterizes “developed” land as areas with a high percentage (30 percent) or greater of constructed materials such as asphalt, concrete, or buildings). There are four subclasses: developed, high intensity; developed, medium intensity; Developed, low intensity; and developed, open space. These four subclasses cover the urban spectrum from large-lot single-family households to apartment complexes.

Given the description of each of CAML’s urban data sources, we can assume that the existing urban layer covers industrial, commercial, and residential areas of a density of one building unit per 1.5 acres of land or higher. The lowest-density households (R.1) are not explicitly mapped for California, and were therefore impossible to mask for growth. Two of the scenarios (Smart Growth and Infill) also have a low-density class R.5 that may be mapped in areas close to city and town centers, but is likely not explicitly mapped in rural parts of the counties.

For five counties in California (San Francisco, Santa Clara, Los Angeles, Ventura, and Orange), the NLCD 2001 layer was used in place of the CAML layer as a mask for existing urban areas. This was done for the four scenarios that used the Base Case residential percentages (Base Case, Fire Threat Avoidance, Biodiversity, and Agriculture scenarios). The existing urban development and/or public lands (also a mask) in these counties was so prevalent that there was not enough space for new development to occur. Because the NLCD 2001 layer was slightly smaller, we felt there were additional lands available that represented possible areas for redevelopment.

### **1.2.3 Allocation of Future Growth**

Once the net attraction grid and the mask grid are generated, the model overlays the two grids, and attraction cells that fall within the mask are converted to “no data” cells, thereby removing them from possible development allocations. This process creates the *suitability* grid, which becomes the template for the allocation of projected land consumed in the future. The suitability grid is overlaid with a grid of the *general plan* land use map, typically a county’s general plan, enabling the model to further identify areas which are suitable for each of the land use categories that will be used (e.g., Figure 2). The model is then ready to allocate projected acres of land consumed in the future. The cells are allocated to each land use category based on how the land use types are designated to the general plan categories. Table 5 shows the default or starting point for UPlan land use type designations to general plan categories. Land uses are listed in order of allocation by the model.

**Table 5: UPlan Land Use Type and General Plan Crosswalk**

<b>UPlan Land Use Type</b>	<b>General Plan Category</b>
Ind	Industry
CH	Commercial High, Urban Reserve, Mixed Use
R50	R100, R1000, Mixed Use, Urban Reserve, Planned Development
R20	R20, R100, R1000, Mixed Use, Urban Reserve, Planned Development
CL	Commercial Low, Planned Development, Mixed Use, Urban Reserve
R10	R10, Planned Development, Mixed Use, Urban Reserve
R5	R10, Planned Development, Mixed Use, Urban Reserve
R1	R1
R.5	R 2 acre+
R.1	R 10 acre

The UPlan land use types are permitted to develop only in the general plan categories that the user specifies in the model.

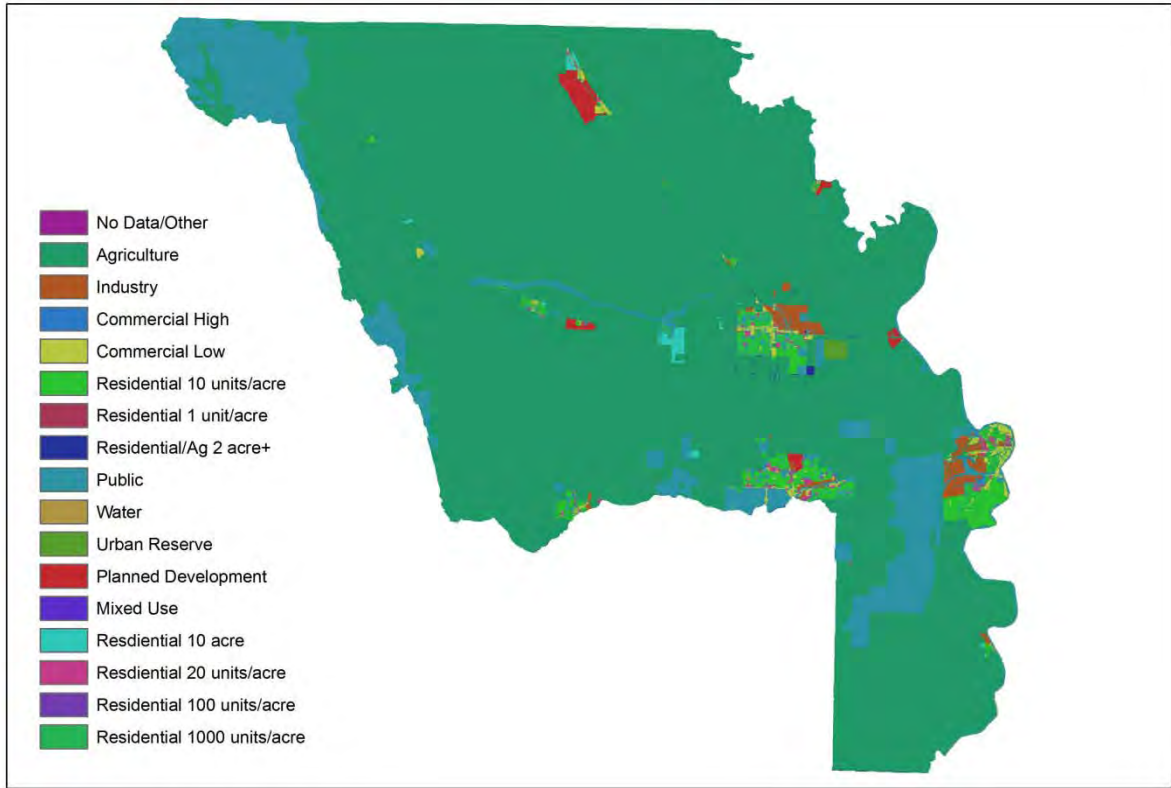

Source: Yolo County Board of Supervisors

**Figure 2: General Plan for Yolo County**

The general plan for each county is the blueprint for the model, to dictate to the model where growth for each land use type is “allowed” to go.

UPlan allocates future growth, starting with the highest valued cells. As the higher-valued cells are consumed, the model looks for incrementally lower-valued cells until all acres of projected land consumption are allocated (Figure 3). The model does this for each of the land use categories.

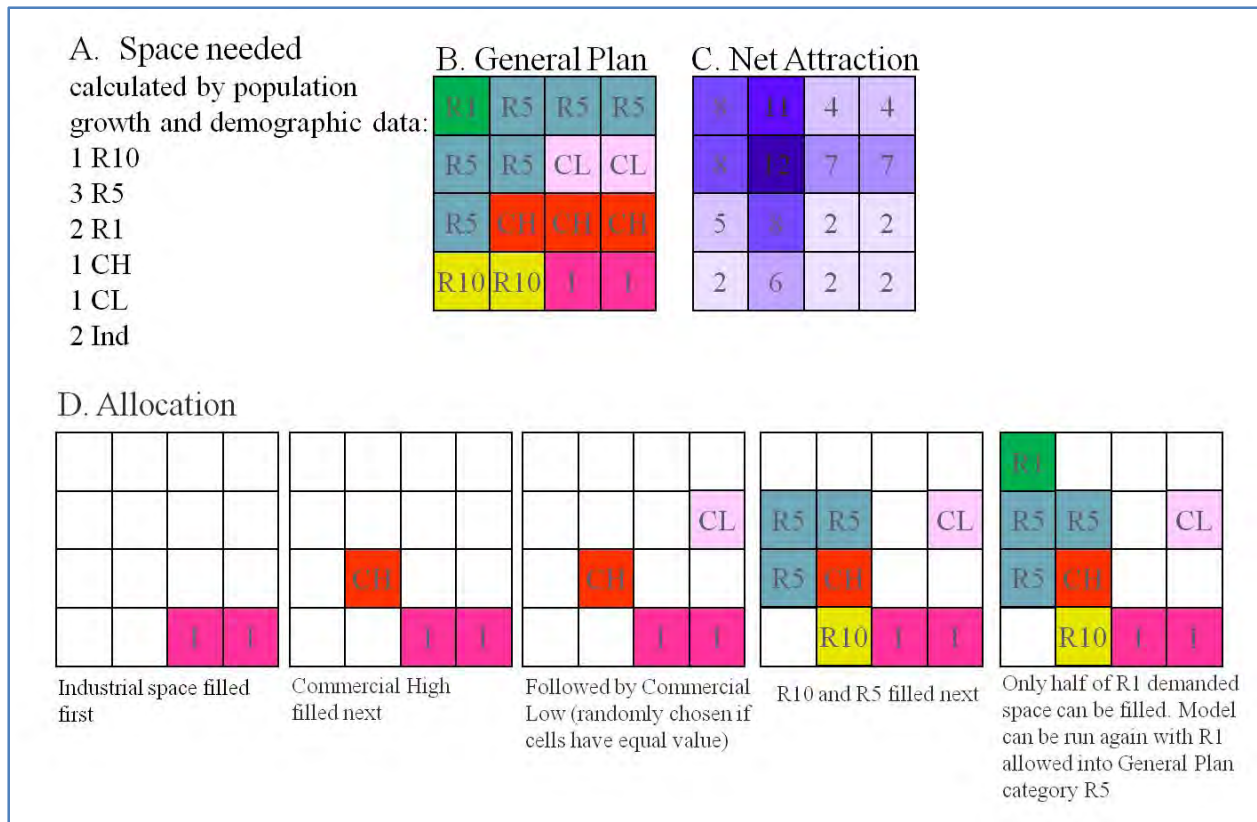

**Figure 3: Allocation by Grid Cell. A: The amount of space needed is determined by the demographic inputs to the model. B: The General Plan grid shows how each cell is designated one General Plan type. While each cell can only have one General Plan type, the user can allow multiple UPlan Land Use Classes to each General Plan type. C: The net attraction layer shows the value of each cell once all of the attractions and discouragers have been added together. D: The allocation of each cell is performed in sequence and according to the general plan and highest net attraction value.**

By default, the model starts with Industry, allocating that use type first, then proceeds to Commercial High, R50, R20, Commercial Low, R10, R5, R1, R.5, and R.1. This sequence is chosen to represent the way in which the land market typically operates – higher-valued land uses are more competitive in acquiring the most desired properties, thereby outbidding the less valuable uses (Johnston et al. 2003). The allocation sequence matters when Mixed Use and Urban Reserve are designated in General Plan.

The allocation routine converts future acres consumed to the number of 50 meter (m) grid cells needed. It then determines how many cells are available in the highest value in the suitability grid, within the correct county zoning, and if this is less than what is needed, simply converts all those cells to the land use type it is allocating at that time. It then subtracts the number of cells it just allocated from the total needed and moves on to the next-highest suitability cell values, and again determines how many cells are available. When the model reaches a point where the cells available are greater than needed, the model completes its allocation of that particular land use by randomly allocating the remaining development to cells within the

current suitability value class. As mentioned above, the allocation occurs within the land use categories that are designated in the general plan cross table.

This allocation method does not apply to R.1, which is randomly allocated throughout rural areas. This is done to represent the prevalent noncontiguous patterns of exurban rural residential development, such as hobby farms at the 10-acre dwelling unit (Johnston et al. 2003). Because the allocation is random, R.1 does not use the suitability grid to find the best locations; however, the mask grid does apply. The R.1 allocation routine starts by making a generic grid of random values. It then makes a list of the values and allocates, in descending order, to the random cells until all acres of R.1 land are used.

After a land use category is allocated, the model makes a new grid of that allocation. This grid is saved in the working directory, but also added to the mask grid so that the next land use type to be allocated does not overlap the previous allocations. Once the model has allocated all the land uses, it merges all of the allocation grids it has created to make the final allocation grid: a grid that has the allocation of all land use types in all zones of the county or region as projected out to the year tested.

## 1.3 Model Inputs

The following is an overview of all of the demographic and spatial data inputs that were entered into the UPlan model. The model is run individually for each county, and therefore the demographic and spatial data are collected for each county. This information is also available as a separate table in Appendix B.

### 1.3.1 Demographic Data

- **Base Population:** The population of the county in the year 2000, according to the U.S. Census. This figure was calculated by subtracting out the population living in institutions.
- **Future Population:** The population of each county in the year 2050, as projected by the Public Policy Institute of California.
- **Persons per Household (PPHH):** Average persons per household for each county, according to the U.S. Census. PPHH is calculated by dividing the population (not including those living in institutions) by the number of households in the county. This number is assumed to be static throughout the 50-year projection period.
- **Residential Percentages:** For each Residential type, the percentage of houses within that category. For R10, R5, R1, R.5, and R.1, categories created from a Special Tabulation by the U.S. Census cross-tabulated dwelling type (single-family attached, single-family detached, and mobile homes) by acreage (<1, 1-9.9, 10+).
  - R50: 50+ unit apartments (U.S. Census Bureau 2000)
  - R20: 2 unit, 3-4 unit, 5-9 unit, 10-19 unit, and 20-49 unit apartments (U.S. Census Bureau 2000)
  - R10: Category created for future scenario; 20 percent of the ratio for R5 from the Base Case Scenario was shifted to R10 for the Smart Growth Scenario
  - R5: Single-family detached homes, <1 acre; single-family attached homes, <1 acre
  - R1: Single-family detached homes, 1-9.9 acres; single-family attached homes, 1-9.9 acres; and mobile homes, 1-9.9 acres

- R.5: Category created for future scenario; 20 percent of the ratio for R.1 from the Base Case Scenario was shifted to R.5 for the Smart Growth Scenario
- R.01: Single-family detached homes 10+ acres; single-family attached homes, 10+ acres; Mobile homes, 10+ acres
- **Employment Percentages:** The ratio of employees in one of three categories (Commercial High, Commercial Low, and Industry) to the total number of employees within the county; Census Transportation Planning Products (CTPP) 2000 (U.S. Census Bureau 2000). See the separate table in Appendix C for CTPP industry to UPlan Industry crosswalk.
- **Emp/HH:** Average number of employees per household for each county, according to the U.S. Census Bureau, 2000. Population 16 years and over in labor force, males plus females, divided by the number of housing units.
- **Average Square Footage per Employee, by Employment Type:** For each employment type, the average number of square feet taken up by each employee. We used a statewide average for each county.
  - Industry: 613 sq.ft./employee; From Nelson (2004) (national average)
  - Commercial Low: 856 sq.ft./employee; from the *2003 Commercial Buildings Energy Consumption Survey* (U.S. Energy Information Administration 2003), Revised June 2006, Table B.1, average for floors 1–3, factored by ratio of mean sq. ft. per worker for the Pacific states (.844).
  - Commercial High: 498 sq. ft./employee; from U.S. Energy Information Administration, *2003 Commercial Buildings Energy Consumption Survey* (U.S. Energy Information Administration 2003), Revised June 2006, Table B.1, average for floors 4–9 and 10 or more floors, factored by ratio of mean sq. ft. per worker for the Pacific states (.844).
- **FAR: Floor-Area Ratio:** Proportion formed by a building’s built floor area (for all floors) divided by the area of its land parcel. For example, a one-story building with a floor plan length and width of 100 feet by 100 feet on the same size land parcel would have a FAR of 1.0.
  - Industry: 0.23
  - Commercial Low: 0.15
  - Commercial High: 0.35

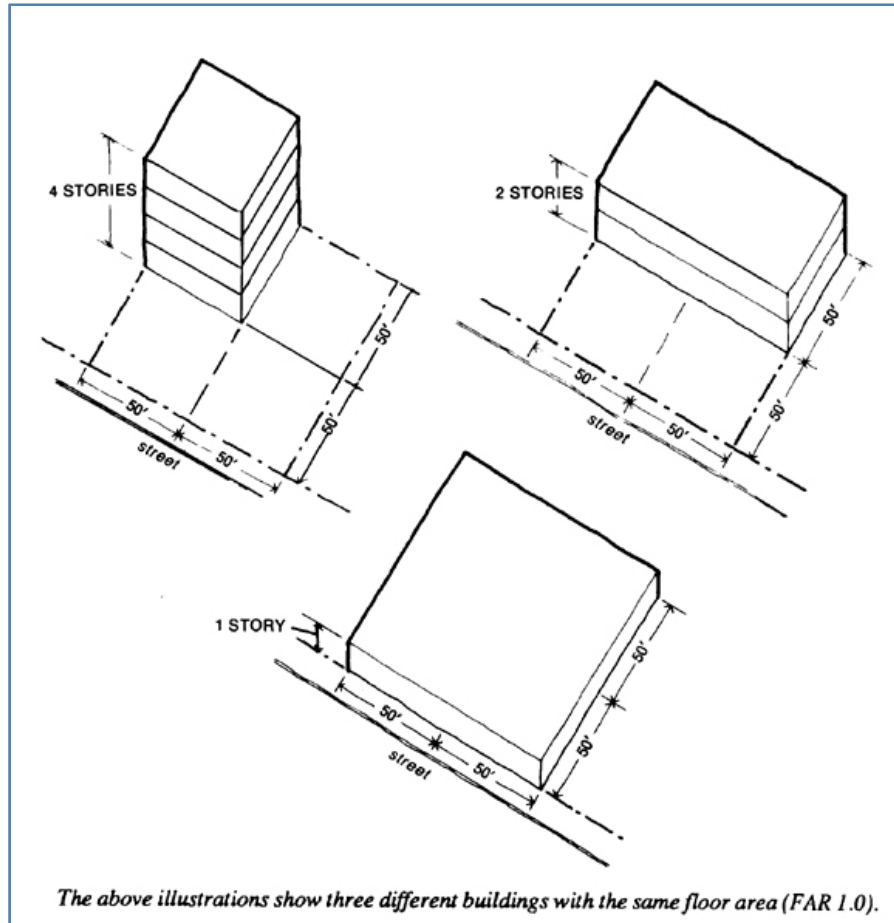

Source: Bloomberg and Burden 2011

**Figure 4: Example of Three Buildings with a FAR = 1**

### 1.3.2 Spatial Data

All spatial data were converted to Albers Equal Area NAD83 prior to use in the modeling environment.

#### 1.3.2.1 Base Layers

- **County Boundary:** Extent of each county (DOC and CAL FIRE 2007)
- **General Plan:** General plan of each county, modified to a standard statewide set of 35 types; these were then further modified to 16 categories for use with the UPlan model

#### 1.3.2.2 Attractors

- **Highways:** Tele Atlas North America, Inc. (Esri 2005); FCC = A2
- **Major Roads:** Tele Atlas North America, Inc. (Esri 2005); FCC = A3
- **Minor Roads:** Tele Atlas North America, Inc. (Esri 2005); FCC = A4
- **Ramps:** Tele Atlas North America, Inc. (Esri 2005); FCC = A63
- **Places:** City boundaries, Census 2000 (U.S. Census Bureau 2000)
- **Blocks with Growth:** Census 1990 and 2000
- **Amtrak Stations:** National Atlas of the United States (Esri 2005)



**Rail Lines:** U.S. Census Bureau 2010. MTDB Super Class “Rail Features” or MTFCC beginning with “R” (main lines, rail yards, mass transit rail lines and special purpose rail lines.

- **Transit Stops:** CalThorpe 2009, unpublished data)

1.3.2.3 *Discouragers*

- **CNDDDB:** California Natural Diversity Database (California Department of Fish and Game, no date), downloaded September, 2010
- **Floodplains:** FEMA Q3 flood zones, downloaded 2005
- **Vernal Pools:** Holland 2005 (revised 2009)
- **Wetlands:** National Wetlands Inventory (U.S. Fish and Wildlife Service; downloaded January 2010) (removed ty = “riverine”)

1.3.2.4 *Masks*

- **Rivers:** National Hydrography Dataset (USGS 2011), NHDLine, streams and rivers
- **Lakes:** National Hydrography Dataset (USGS 2011), NHDWaterbody, lakes and ponds
- **CPAD:** California’s Protected Areas Database (GreenInfo Network 2010). Units Fee.
- **Existing Urban:** California Augmented Multisource Landcover Map (CAML;Hollander 2010)

**1.4Outputs**

**1.4.1 Spatial Output**

UPlan creates an allocation raster grid for each county, with separate values for each land use type. Table 6 shows the value-to-land use crosswalk. Figure 5 shows the standardized colors used to depict various land use types.

**Table 6: Raster Cell Value to UPlan Land Use Type Crosswalk**

Cell Value	UPlan Land Use Type
9	Residential 20
10	Residential 5
12	Residential 1
13	Residential .1
15	Residential 50
16	Residential .5
17	Industrial
18	Commercial High
19	Commercial Low
20	Residential10



**Figure 5: Legend for UPlan Land Use Output**

Each county is run in the model until all of the demanded space was allocated. Starting with the default UPlan land use type to general plan categories crosswalk, the model is run once. If all of the space desired by the model is allocated, the output is considered complete. If all of the desired space is not allocated, the model is run a second time, this time opening another of the general plan categories to the land use type that was not fully allocated. For example, if Alameda County did not fully allocate the desired amount of Residential .1, due to lack of space in the general plan category R 10 acre, the subsequent run would allow Residential .1 to also move into General Plan space R1. A guide was followed to maintain consistency in the output runs and to follow as closely as possible the general plan for that county. Table 7 shows the order in which general plans are opened in the event that insufficient default space was available. The specific UPlan land use type/general plan categories crosswalk for each county is available by looking at the General Plan worksheet table for that county's report, detailed in the following section.

**Table 7: Guide for Adding Additional General Plan Categories to Available Development Space**

UPlan Land Use Type	General Plan Category	Additional Categories to Be Added If Space Unallocated
Ind	Industry	Urban Reserve
CH	Commercial High, Urban Reserve, Mixed Use	Commercial Low, Industry, R2 acre+, R10 acre, Agricultural
R50	R100, R1000, Mixed Use, Urban Reserve, Planned Development	R20, R10, R1, R2 acre+, R10 acre, Agricultural
R20	R20, R100, R1000, Mixed Use, Urban Reserve, Planned Development	R10, R1, R2 acre+, R10 acre, Agricultural
CL	Commercial Low, Planned Development, Mixed Use, Urban Reserve	Commercial High, Industry, R2 acre+, R10 acre, Agricultural
R10	R10, Planned Development, Mixed Use, Urban Reserve	R20, R100, R1000, R1, R2 acre+, R10 acre, Agricultural
R5	R10, Planned Development, Mixed Use, Urban Reserve	R20, R100, R1000, R1, R2 acre+, R10 acre, Agricultural
R1	R1	R 2 acre+, R 10 acre, Agricultural
R.5	R 2 acre+	R1, R 10 acre, Agricultural
R.1	R 10 acre	R1, R 2 acre+, Agricultural

### 1.4.2 Tabular Outputs

In addition to spatial outputs, the model will also generate a tabular report that details the spatial and demographic inputs that went into the run, as well as the resulting allocation amounts for each land use type.

The report is a Microsoft Excel document with 11 worksheets detailing different parts of the model. Each time a county run is successfully executed, a report can be generated. For all county runs that produced an output for the statewide scenario, a report is provided.

#### 1.4.2.2 General Info

The first worksheet, General Info, states the location of the output, the model type, and the Geographic Region, which will be the county name.

#### 1.4.2.3 Results

The second worksheet, Results, shows the model allocation demand and actual allocation, in number of 50 meter cells and acres. If any UPlan land use type did not have sufficient space in the county, there will be positive values in the final two columns, showing the amount of space that is still needed. For example, the report for an early run for Ventura County, in Table 8, shows a substantial amount of R5 and CL, as well as lesser amounts in other types, was needed

to accommodate the new growth but not allotted any space. In subsequent model runs, other general plan types could be opened to the under-allocated UPlan types to try to accommodate all of the demanded growth.

**Table 8: UPlan Report Showing the Results for a Ventura County Run**

Model Run Allocation Area: Demand				Model Run Allocation Area: Actual				Under Allocation	Under Allocation
Land Use	Cells	Acres		Land Use	Cells	Acres	Cells	Acres	
Residential 20	4,978	3,075		Residential 20	461	285	4,517	2,790	
Residential 5	25,183	15,557		Residential 5	8,376	5,174	16,807	10,383	
Residential 1	9,482	5,858		Residential 1	9,482	5,858	0	0	
Residential .1	16,265	10,048		Residential .1	16,274	10,053	-9	-5	
Residential 50	292	180		Residential 50	292	180	0	0	
Residential .5	1,084	670		Residential .5	1	1	1,083	669	
Industrial	5,377	3,322		Industrial	3,302	2,040	2,075	1,282	
Commercial High	3,578	2,210		Commercial High	2,465	1,523	1,113	687	
Commercial Low	30,912	19,096		Commercial Low	1,598	987	29,314	18,109	
Residential 10	4,123	2,547		Residential 10	4,123	2,547	0	0	

Because of the large lot size of R.1, as well as the fact that UPlan must convert cells to acres, the under-allocation amount for that residential class is sometimes a small negative number. This is considered a rounding error and treated as a 0, or full allocation.

**1.4.2.4 Results by Traffic Analysis Zone (TAZ)**

This tab allows the user to summarize the amount of land, households, and employees by traffic analysis zone (TAZ), if a TAZ grid is added to the model beforehand.

**1.4.2.5 Discouragement Impact**

The amount of land that is developed in the model that also coincides with land from a discouragement layer (e.g., floodplains, vernal pools) will be recorded by the model and the output added to the Discouragement Impact worksheet. The amount of land that overlaps will be recorded in acres for each land use type and each discouragement layer.

**1.4.2.6 Demographic Inputs**

This page shows the demographic inputs that went into the model, including the base population, future population, persons per household, and employees per household. Five other fields are also included on the worksheet, but were not used in the setup of the two statewide UPlan outputs.

#### *1.4.2.7 Residential Inputs*

The percentage and average lot size of each residential land use type that was entered into the model are shown on this page.

#### *1.4.2.8 Employment Inputs*

This page shows the percentage of each employment type, as well as the average square footage per employee and floor-area ratio (FAR).

#### *1.4.2.9 Attractions*

This page shows the spatial layer name, buffer class, and weight of each attractor in the model. Any of these elements can be altered by the user, and represent an interesting way to alter scenarios according to policy demands.

#### *1.4.2.10 Discouragements*

Similar to Attractions, this page shows the spatial layer name, buffer class, and weight of each discouragement in the model.

#### *1.4.2.11 Masks*

This section lists the spatial layer name for areas that were completely excluded from development in the model. These layers can also be buffered by a distance (e.g., a one-mile radius around a lake) in the model.

#### *1.4.2.12 General Plans*

This page shows the crosswalk between the General Plan types and the UPlan Land Use types, as described in Section 1.4.1. Table 9 shows the values for the General Plan types that were used in the model.

**Table 9: General Plan Codes for Use with the UPlan Report**

Unclassified	0
Agriculture	1
Industry	2
High density commercial	3
Low density commercial	4
High density residential (R5/R10)	5
Medium density residential (R1)	6
Low density residential (R.5)	7
Public lands & open space	8
Water bodies	9
Urban reserve	10
Planned development	11
Mixed uses	12
Very low density residential (R.1)	13
Residential MF max 20 units/acre	14
Residential MF max 100 units/acre	15
Residential MF max 1000 units/acre	16

## Section 2: Scenarios

### 2.1 Base Case

The Base Case Scenario represents the “business-as-usual” trend of development, with no policy effort made to restrict growth from sprawling outside of city limits (Figures 6 and 7). This scenario works under the assumption that the same development trends that have existed in the past will continue on into the future. The Base Case Scenario is meant to stand as a perspective to which alternative scenarios can be compared.

The available land use types are as follows: R20, R5, R1, R.1, CH, CL, and Ind. (See 1.3.1 Demographic Data for a detailed description of UPlan’s land use types.) The change in population between the base year (2000) and future year (2050) was calculated for each county, using the Public Policy Institute of California (PPIC) for the future year 2050, and the Census for the 2000 base year. Persons per household figures were taken from the 2000 Census as well, to give us the amount of new households needed for each county. We then used the existing distribution of household density types to dictate the distribution of density types for our Base Case Scenario (see residential percentages in Section 1.3.1 Demographic Data). Thus, if historically Butte County had 48 percent of households described as R5, the future development for Butte County would continue that same trend, and 48 percent of the new households would be built as R5 density residential units.

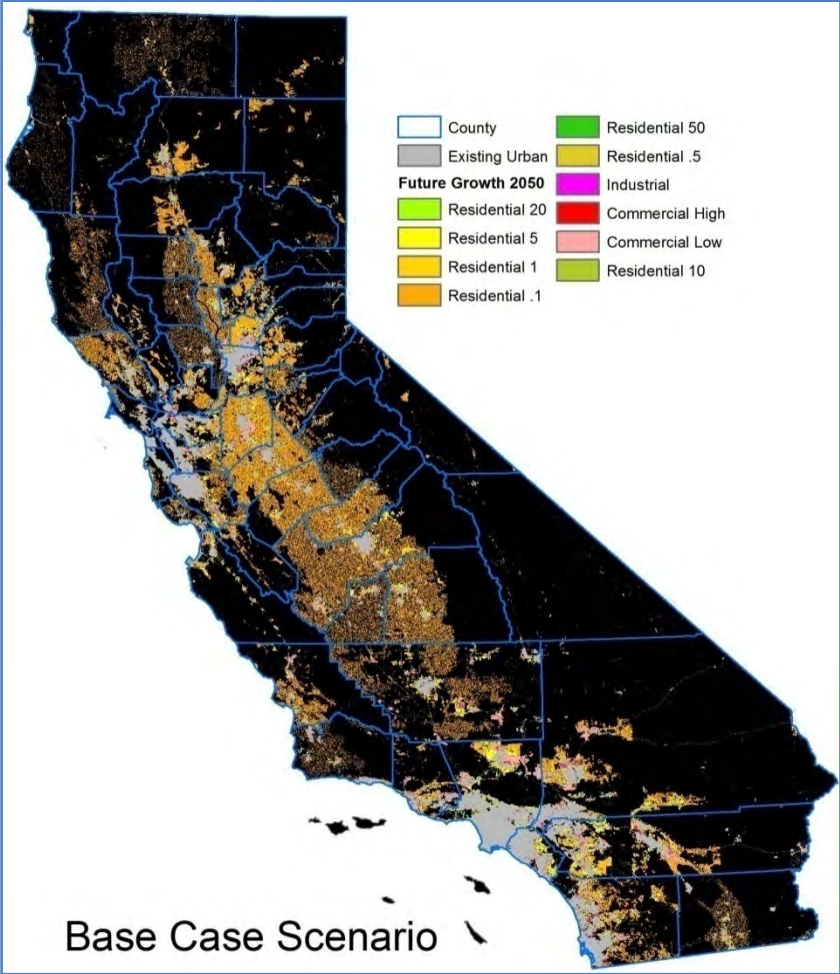

Figure 6: Statewide UPlan Output, Base Case Scenario



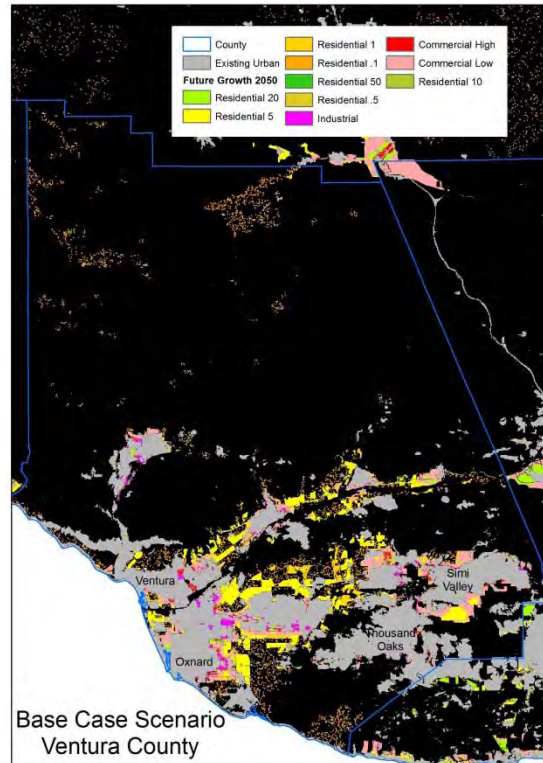

Figure 7: Statewide UPlan Output, Ventura County, Base Case Scenario

## 2.2 Smart Growth

The Smart Growth Scenario represents policy efforts to somewhat restrict growth into rural areas and encourage growth closer to city centers (Table 10). The end result will hopefully reduce the amount of sprawl and compact the new development toward existing urban cores (Figures 8 and 9). However, the smart growth scenario, as we defined it here, does not include redevelopment of any existing urban areas. The standard set of weights and buffers were used for each attractor and discourager for each county as with the Base Case, with the following exception. The Places spatial attractor layer, representing city centers, was given twice the weight as with the Base Case Scenario. The cells within the buffered area of the Places were thus twice as attractive to growth for the Smart Growth Scenario as for the Base Case Scenario.

The other difference between the Base Case Scenario and the Smart Growth Scenario was the land use classes. Three additional land use types were added to the Smart Growth Scenario: R50, R10, and R.5. The percentages of housing units within these types were altered from the Base Case using the following table:

**Table 10: Modifications to Residential Land Use Proportions for Smart Growth Scenario**

Land Use Type for Smart Growth	Corresponding Land Use Type in Base Case
R50	20% R20
R20	20% R5 + 80% R20
R10	20% R5
R5	60% R5 + 20% R1
R1	80% R1 + 20% R.1
R.5	20% R.1
R.1	60% R.1

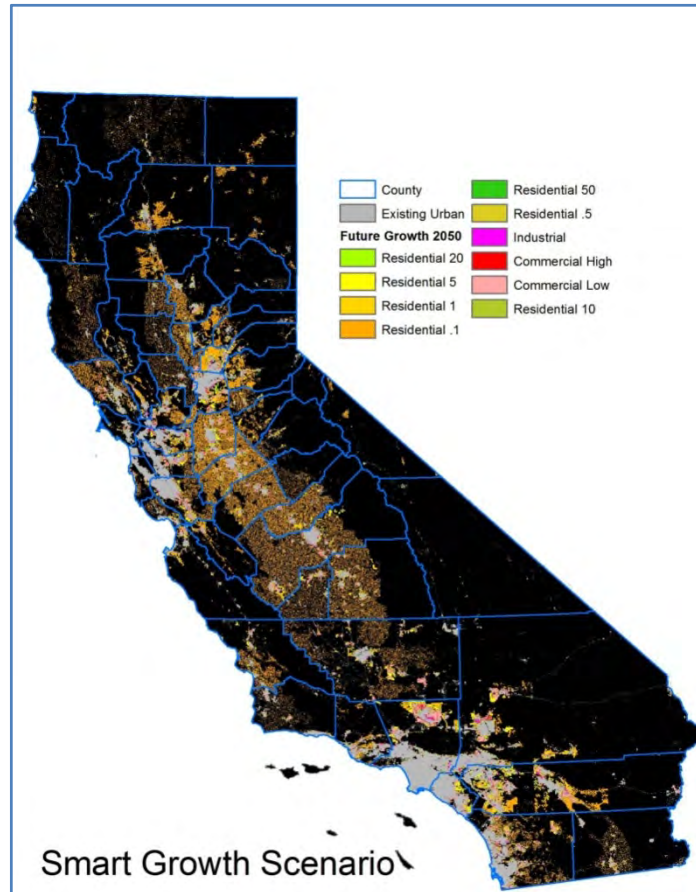

**Figure 8: Statewide UPlan Output, Smart Growth Scenario**

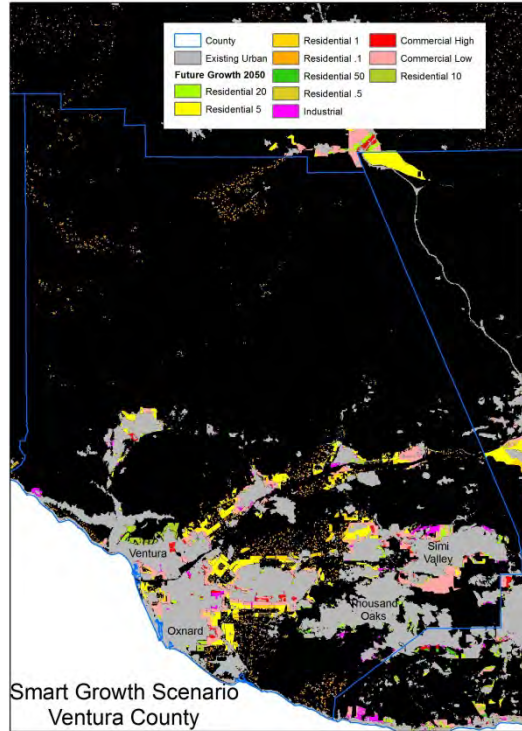
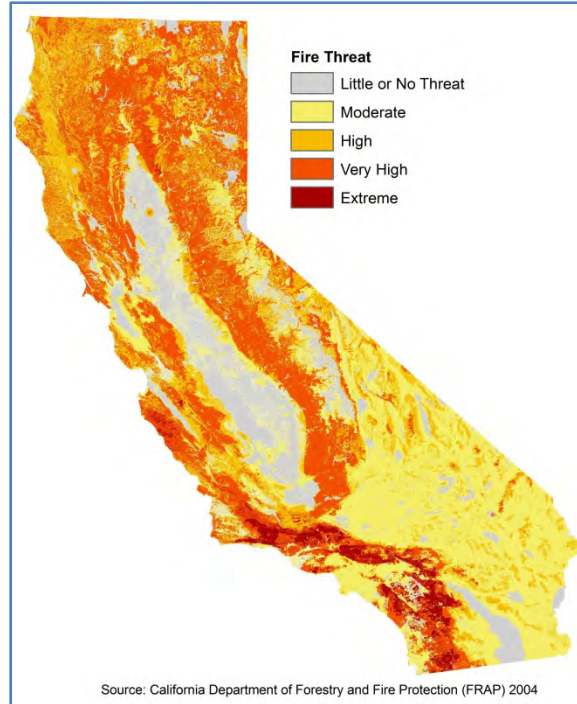

**Figure 9: Statewide UPlan Output, Ventura County, Smart Growth Scenario**

### 2.3 Fire Threat Avoidance

This scenario assumes a policy that restricts growth in areas of high wildfire threat. Using the California Department of Forestry and Fire Protection (FRAP) 2004 Fire Threat Statewide GIS layer (FRAP 2004, <http://frap.cdf.ca.gov>), we selected areas with various levels of threat for wildfire and avoided new residential and commercial growth in those areas. This scenario addresses existing fire risk concerns but does not incorporate future fire risk exposure, which may be higher and have different spatial patterns to the current assessment.

The Fire Threat layer combines expected fire frequency with potential fire behavior to create four threat classes to urban extents: Extreme, Very High, High, and Moderate (Figure 10). For this scenario, the three most severe threat classes were given a discourager weight which was applied to new growth in both the residential and commercial classes. These threat areas were not buffered. The Extreme threat class was given a discourager weight of 60; the Very High class a weight of 40; and the High class a weight of 20.



**Figure 10: FRAP Fire Threat Map. These different threat classes denote the different discourager weights for the Fire Threat Avoidance Scenario.**

Aside from the discouragers related to fire threat, the other geographic and demographic inputs were identical to the Base Case Scenario.

The overall impact statewide was quite noticeable, as shown in Figure 11; whereas individual county runs varied depending on the amount of threatened areas within that county. The graphs below show the difference in area of overlapping new growth with fire threat areas between the Base Case and Fire Avoidance scenarios.

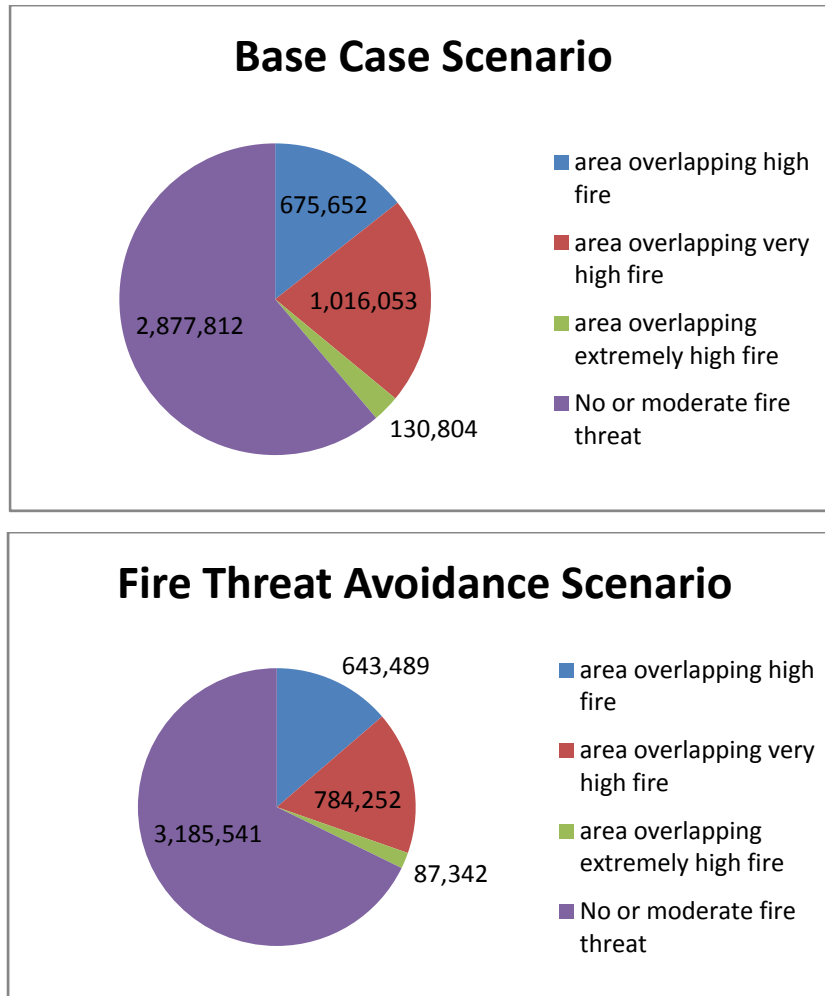

**Figure 11: Comparison of the Area (acres) of Residential and Commercial Growth Over Fire Threat Areas, Base Case and Fire Threat Avoidance Scenarios**

Figure 12 shows a close-up of Santa Barbara County, one of the counties with a substantial amount of area threatened by fire. The first map shows the new residential growth from the Base Case Scenario, which overlaps significantly the areas of fire threat.

The second map shows the Fire Threat Avoidance Scenario, with much less of the new growth being developed in the threatened areas.

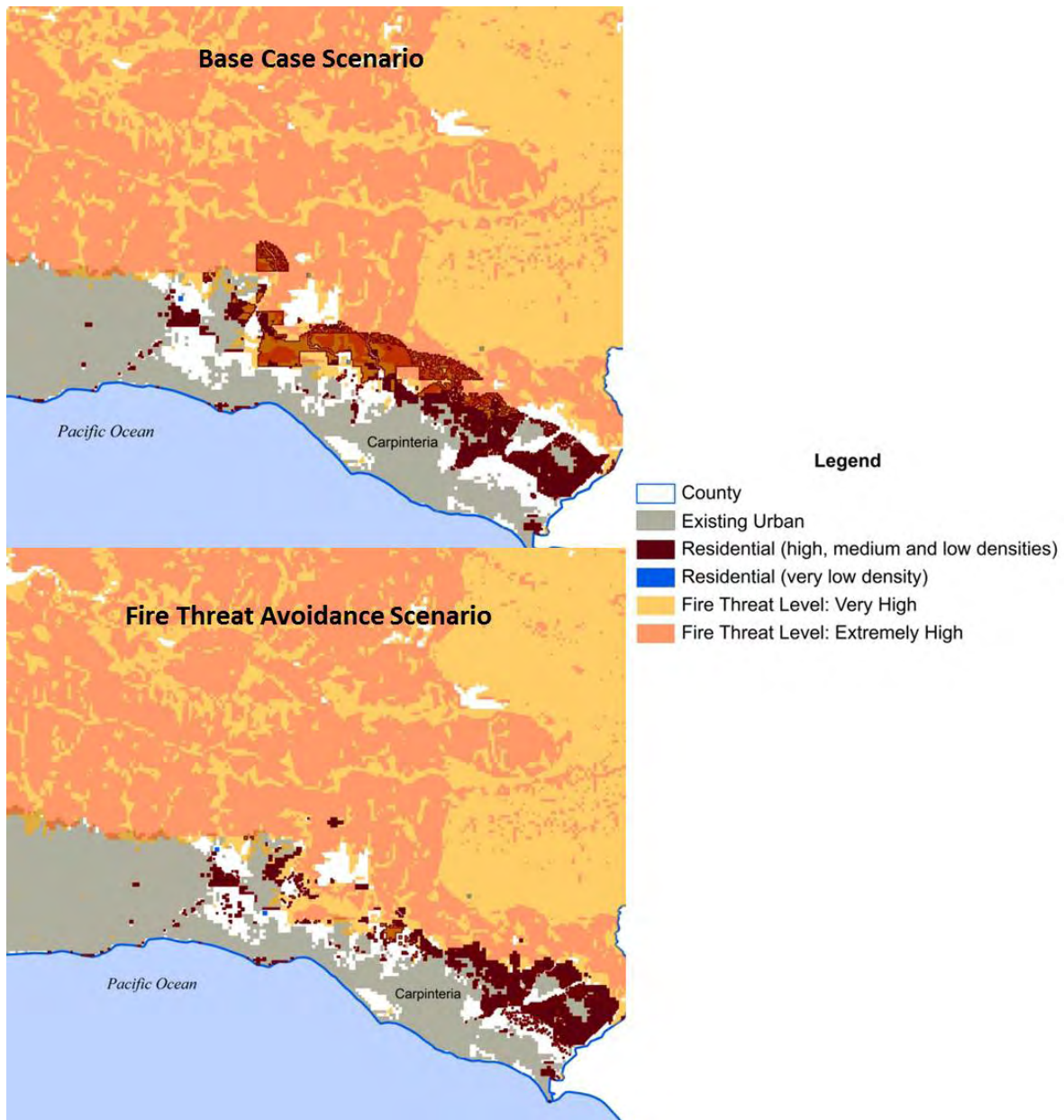

**Figure 12: A Close-up of Santa Barbara County, one of the Counties with a Substantial Amount of Area Threatened by Fire. The First Map Shows the New Residential Growth from the Base Case Scenario, Which Overlaps Significantly the Areas of Fire Threat.**

## 2.4 Infill Scenario

The Infill Scenario supposes a policy with more intensive measures toward compact growth and reduction of sprawl, with 50 to 100 percent of each county's new development occurring within the existing urban extent. Input on approaches for the Infill Scenario came from several people and organizations, including the Association of Bay Area Governments (ABAG), Greenbelt Alliance, and Landscape Architecture and Environmental Design professor Stephen Wheeler at the University of California (UC) Davis. The consensus for the scenario was that

high levels of infill and redevelopment would be necessary to make a more aggressive impact on reducing landscape sprawl and meeting requirements for Assembly Bill 32 and Senate Bill 375 on the reduction of greenhouse gas emissions in California. Note that redevelopment, the retrofitting or reconstruction of existing buildings is part of infill, but infill also assumes the development of empty lots within the urban extent.

To simulate this policy, we allowed the new population to be placed into already existing urban areas, which effectively represents urban area infill. For both the infill and for any additional areas developed outside the urban boundary, we increased the density of new residential housing and commercial buildings (Figure 13). New attractor layers were also added to encourage growth near already-urbanized areas and existing public transportation hubs. The final output for this scenario was the combination of two separate model runs for each county.

For the first run, several changes were made to both the spatial and demographic inputs. First, three new spatial layers were added as attractors to growth in each county: Amtrak Stations, Transit Stops, and Rail Lines. The attraction weights used for these new layers are identical to that of the Highway layer (see separate table Appendix D for details), and the attractors were applied to all buffer classes except Industry. This was done to pull growth toward these layers, which both simulate a policy to encourage public transportation and in general pull growth toward city centers, where these geographic layers tend to exist. Second, the Existing Urban layer was added as an attractor to all buffer classes, using the same weight as that of the Places layer for the Smart Growth Scenario. Third, the same Existing Urban layer was removed as a mask to growth. Fourth, the General Plan layer was changed so that the areas of the General Plan layer that overlapped with the Existing Urban layer were given a new value of 17, representing infill. The infill value 17 was then added to all residential and commercial UPlan types, so that the infill areas could be allocated by any UPlan land use type. And last, the order in which each land use class was allocated in the model was altered slightly to encourage the highest density residential class's ideal placement in city centers.

For tabular inputs, several more changes were made. First, the highest density residential types were allowed into any general plan type, and were allocated first, giving these types the highest priority as the model allocates the space. Second, the square footage/employee figures were cut by 50 percent, representing a policy reduction in commercial space allotment (Table 11). Last, the residential densities were shifted once more to transfer more households to a higher density than that dictated by the Base Case trend. This time, the shifts from lower to higher density residential types were more acute, resulting in a much more compact housing structure. Figure 13 shows how the Infill Scenario types correspond to those in the Base Case Scenario.

**Table 11: Average Square Footage per Employee by Commercial Class**

Commercial Class	Infill Scenario (sq.ft./employee)	All other scenarios (sq.ft./employee)
Commercial High	249	498
Commercial Low	428	856
Industrial	306.5	613

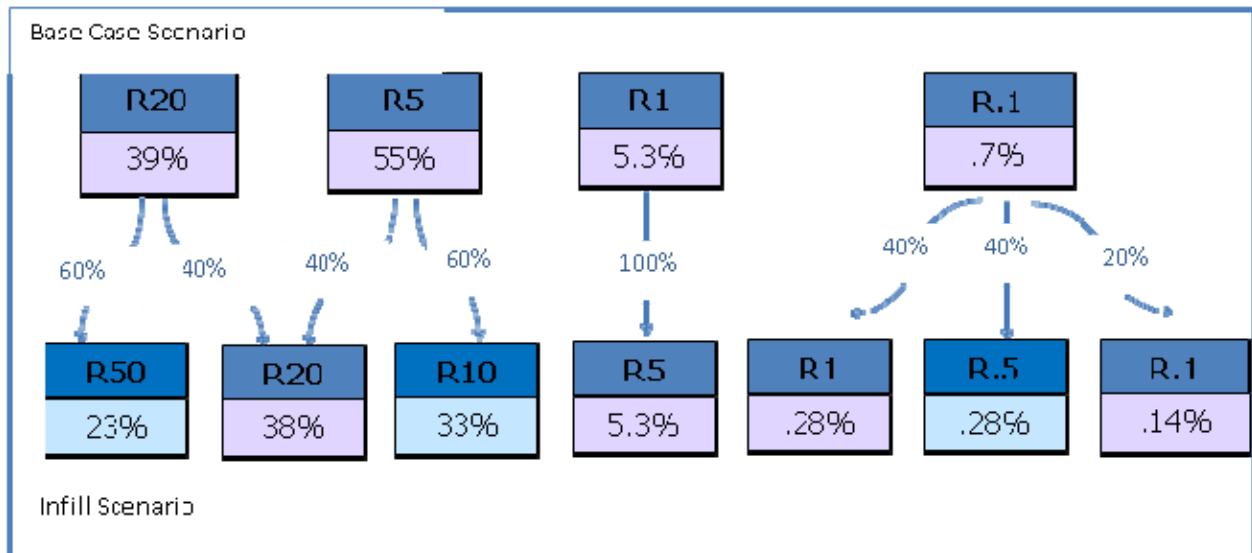

**Figure 13: Densification Process of Residential Classes for a Sample County (San Diego County)**

After each county was successfully run a first time, we overlaid the output on a population and employment surface for the year 2000, using Census 2000 data by block for population and CTPP (Census Transportation Planning Package) 2000 data for employment numbers. We could then determine the number of residents and employees who occupied the spaces in the year 2000 that were subsequently redeveloped.

The number of residents and employees that were “displaced” by the future redevelopment were then added as inputs to the second run of the model. This time, only the displaced individuals were modeled, and at even-higher housing and employment densities (Table 12). The same attractors were left in place as for the first run, but the existing urban and first run were added as masks to growth, this time forcing development to go outside urban boundaries (Figure 14).



**Table 12: Inputs for Second Run of Infill Scenario**

Land Use Type	Infill Scenario (%)	All other scenarios (%)
R50	50	Variable
R20	25	
R10	25	
R5	0	
R1	0	
R.5	0	
R.1	0	
CH	85	
CL	10	
Ind	5	

Once both model runs were successfully verified, the two outputs were combined and the zonal summaries could be calculated to determine the population and area of the total new population (including those “displaced” individuals) within existing urban boundaries (see Appendix E for zonal summaries by county). Figure 15 shows the acreage total for the footprint of new development for Fresno County, for three of the scenarios.

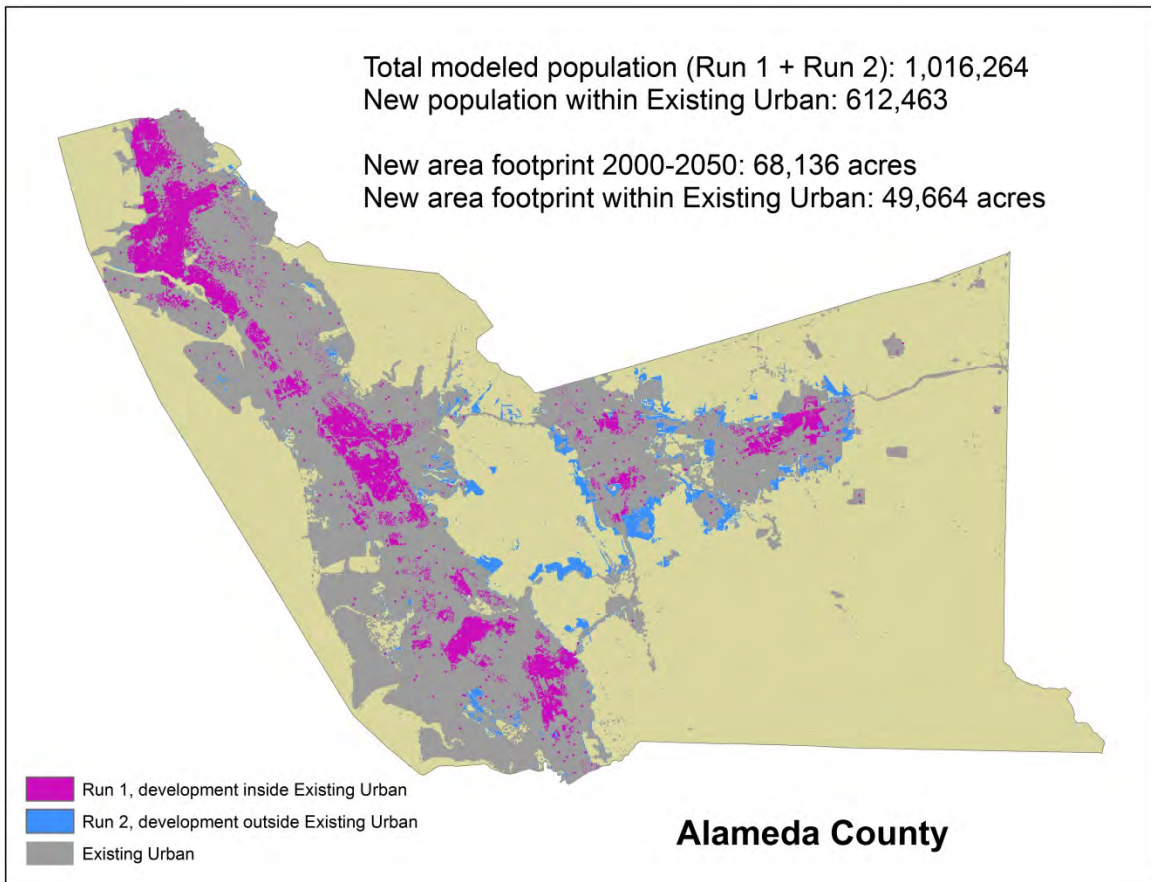

**Figure 14: Infill Scenario Example for Alameda County. 612,599 new residents are projected for the year 2050. The first run places 612,463 residents within the urban extent, displacing 403,665. The displaced residents are added in the second run, just outside the existing urban extent.**

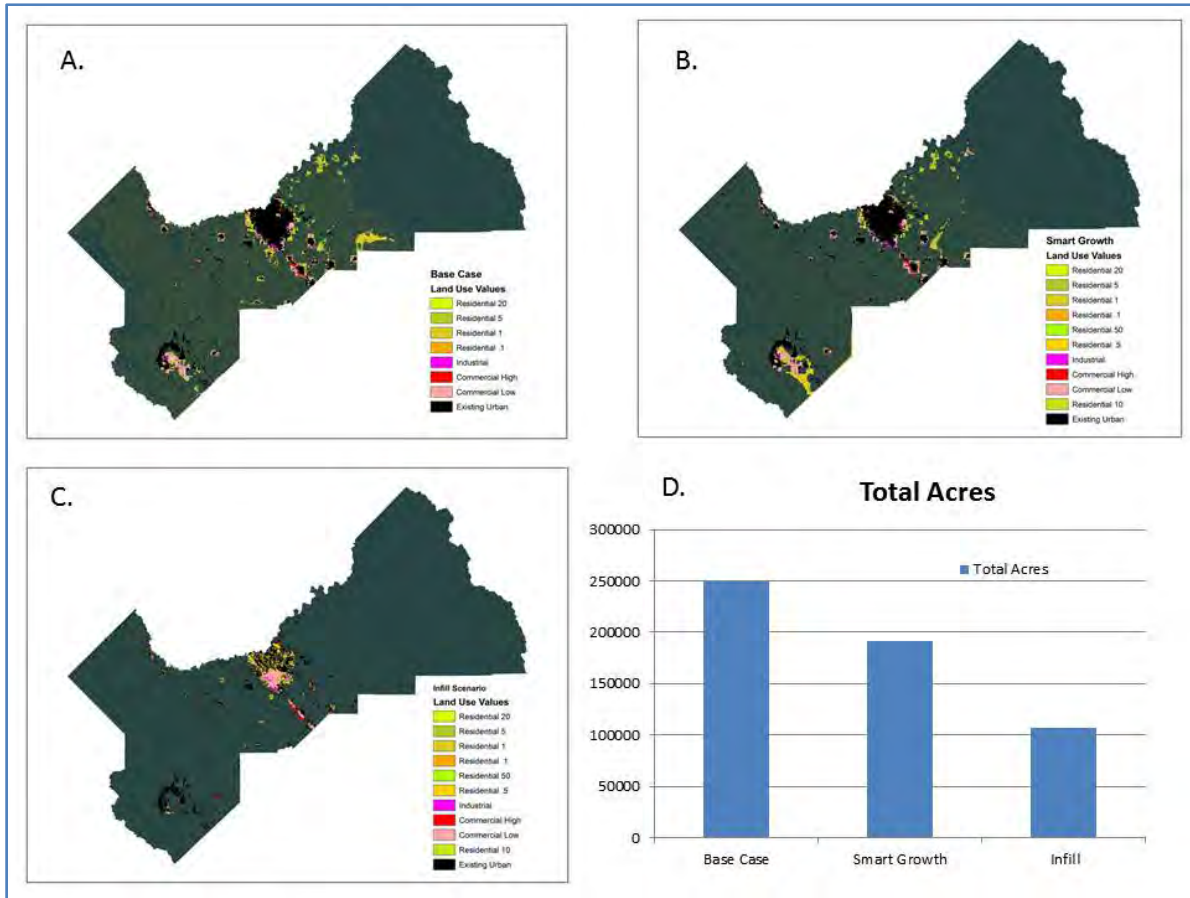

**Figure 15: Comparison of the Final Outputs for Each Scenario for Fresno County. A. Base Case Scenario. B. Smart Growth Scenario. C. Infill Scenario. D. Chart Showing Total Amount of Acres of Development for Each Scenario.**

## 2.5 Biodiversity Scenario

This scenario examined priority areas for the conservation of native California plant species, in the current time, but primarily focused on potential futures under climate change as modeled by Lee Hannah, and others at the University of California, Santa Barbara (Hannah et al.2012). The plant taxa model, called the Network Flow Model, begins with nodes of currently suitable habitat for multiple groups of species, then adds future nodes of suitable habitat. Chains, or landscape corridors that would permit the passage of plant species to newly suitable locations, were created when the current time period nodes were connected to nodes in the next time step. The future nodes were identified from species distribution maps based on two climate model outputs (A2 scenario, Parallel Climate Model [PCM] and Geophysical Fluid Dynamics Laboratory [GFDL] model), two time periods (2000–2050 and 2000–2080), two conservation targets (100 and 1000 square kilometers [km<sup>2</sup>]), and two dispersal radii (6.3 and 10.5 km). The output from the Network Flow Model is a raster dataset with a 4.2 km cell size. The result is a network of cores and corridors that have been identified as important to the persistence of over 2,000 plant species in California.

For our biodiversity UPlan model run, we used the Network Flow Model outputs as discouragements to new growth, simulating a policy toward prioritizing conservation habitats for native California flora. We used only one time period, 2000–2050, as 2050 is the ending time period for our UPlan model and the larger of the two dispersal radii. The two climate model outputs and two conservation targets were combined to provide a range of discouragement weights, outlined in Table 13. The heaviest discouragement weight was targeted as a counterbalance to the highest attractor weight, which is used for the Places layer with no buffer. Note that areas designated as important federal lands to this biodiversity measure are already considered protected in the UPlan scenarios, and so were not used. See Appendix D for a list of all attractor and discouragement weights.

**Table 13: Table Showing the Different Combinations of Overlap Between the Climate Scenarios and Conservation Targets and their Corresponding Discouragement Weights. The highest weights occur when both climate scenarios predict a conservation target for a given climate model.**

Weights	100 km <sup>2</sup> Target Only	1000 km <sup>2</sup> Target Only	Both Targets	
40		PCM only		
40	GFDL only			**
40		GFDL only		
45		GFDL and PCM		
50	GFDL only	PCM only		**
50	GFDL only		PCM only	**
50			PCM only	
50			GFDL only	
55		GFDL only	PCM only	
55		PCM only	GFDL only	
60			GFDL and PCM	

\*\*There was only one cell present in study area for this combination; it was therefore assigned the same weight as the next-highest category.

Note: There are other possible combinations not shown because those combinations were not present in the study area.

The resulting output shows a marked decrease in development in conservation target areas with high discouragement weights for some areas of the state, particularly along the Central Coast (Figure 16). In counties where high population increases and resulting high demand for housing creates a shortage of available space for development, such as Santa Clara County, the discouragement weights have less effect in reducing development in conservation target areas.

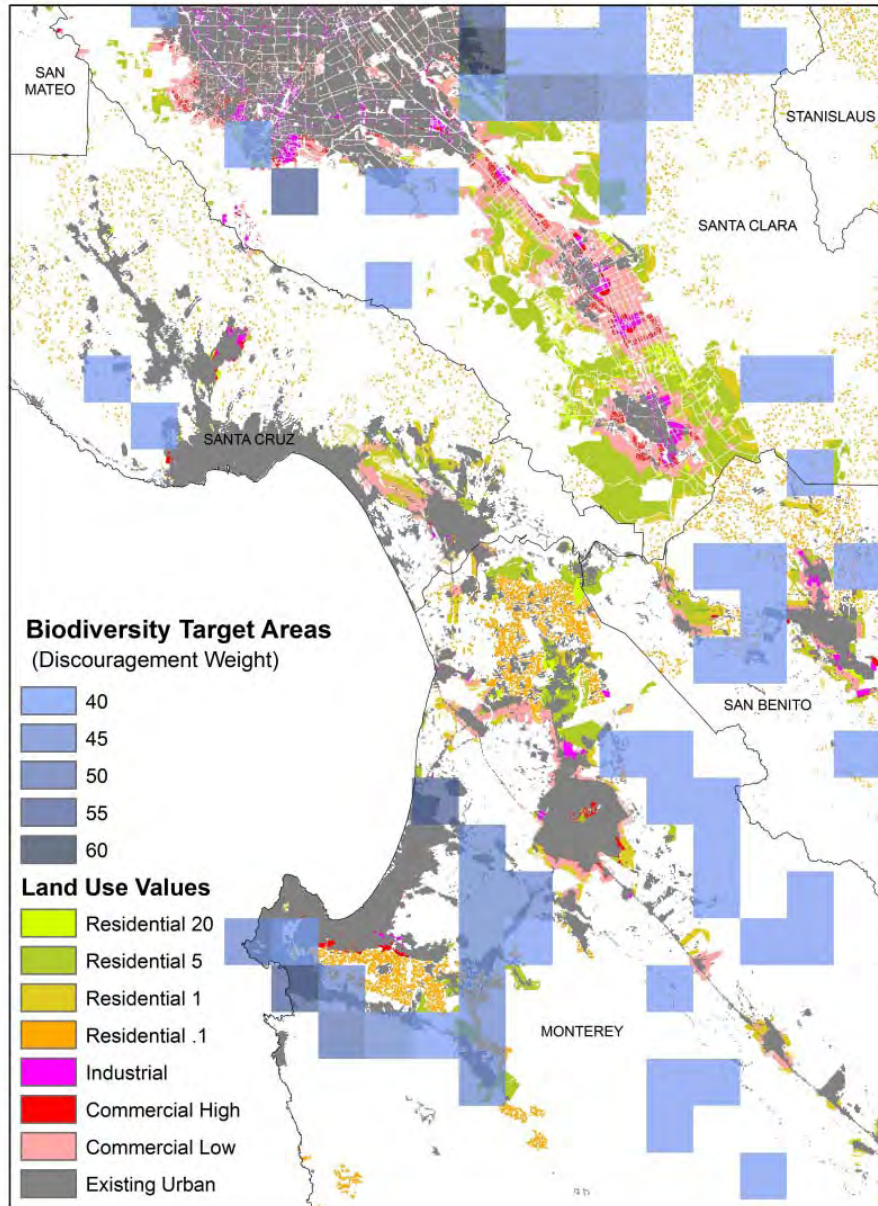

Source: Hannah et al. 2012, authors.

**Figure 16: The Central Coast of California Showing the Biodiversity Target Areas and the Biodiversity UPlan Model Output**

## 2.6 Agriculture Scenario

For the agriculture scenario, we worked with the PIER Vulnerability and Adaptation group that was focused on climate effects on agriculture (Jackson et al. 2012). As part of their work they developed mapped subcomponents that went into an overall agricultural vulnerability score, which was mapped to California using 12.5 km<sup>2</sup> grids. We used two of the inputs to this ranking as inputs for a UPlan model run: crop climate sensitivity index and crop dominance index. The crop climate sensitivity index scores crop vulnerability by measuring the total

statewide area of 72 crop categories mapped in the California Augmented Multi-purpose Land-cover (CAML) dataset (Hollander2010). The rationale for this index is that crops with a small cultivated area are more vulnerable than more widespread crops due to restricted climatic conditions. An index value was calculated for each crop between zero and one, with the most highly sensitive crops closest to one. An area-weighted average for all crops within each grid cell was then calculated. The crop dominance index measures agrobiodiversity (crop diversity), or the number of different crop types that are found in an agricultural landscape. The idea behind this index is that large areas dominated by single crops are more vulnerable to change than highly diversified systems. This index ranges from zero to one, with the least diversified crops closest to one. These two indices were then averaged together, and a classification was created based on the standard deviation (Figure 17). For a complete description of the methods and assumptions behind these indices, see Jackson et al., in review.

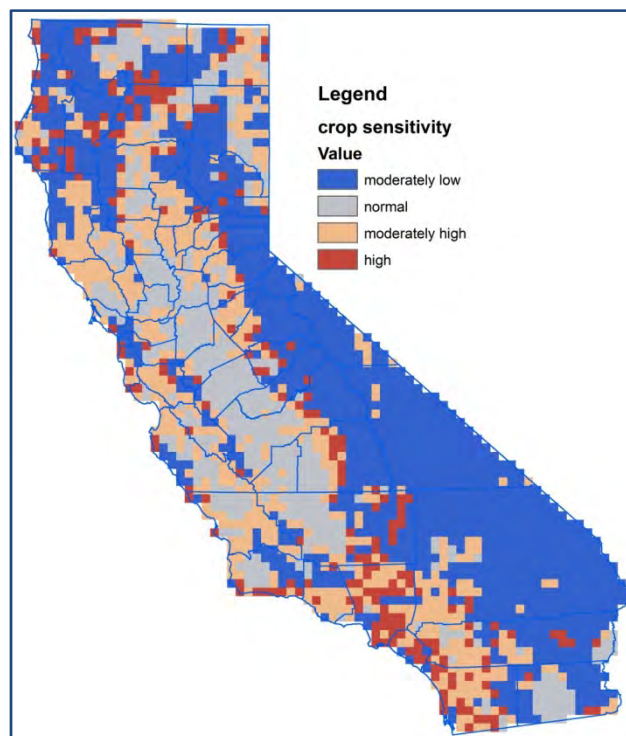

Source: Jackson et al. 2012

**Figure 17: Crop Sensitivity Index**

The Agriculture Scenario for UPlan seeks to avoid development in areas classed as moderately high and high for crop sensitivity. For the purposes of the UPlan Model, we clipped the crop sensitivity grid to just the areas where crops are currently located, so that the larger grid cells from the crop sensitivity index had less of an impact on the smaller 50 square meter (m<sup>2</sup>) cells used in UPlan. We gave areas with “high” crop sensitivity a discouragement weight of 60, and areas of “moderately high” crop sensitivity a discouragement weight of 50, to balance the highest weights of the attractor areas in UPlan. All other data inputs were identical to the Base Case Scenario. See Appendix D for a list of all attractor and discouragement weights. For two counties, there were no “high” or “moderately high” crop sensitivity areas, so UPlan base case outputs for these counties were used instead.

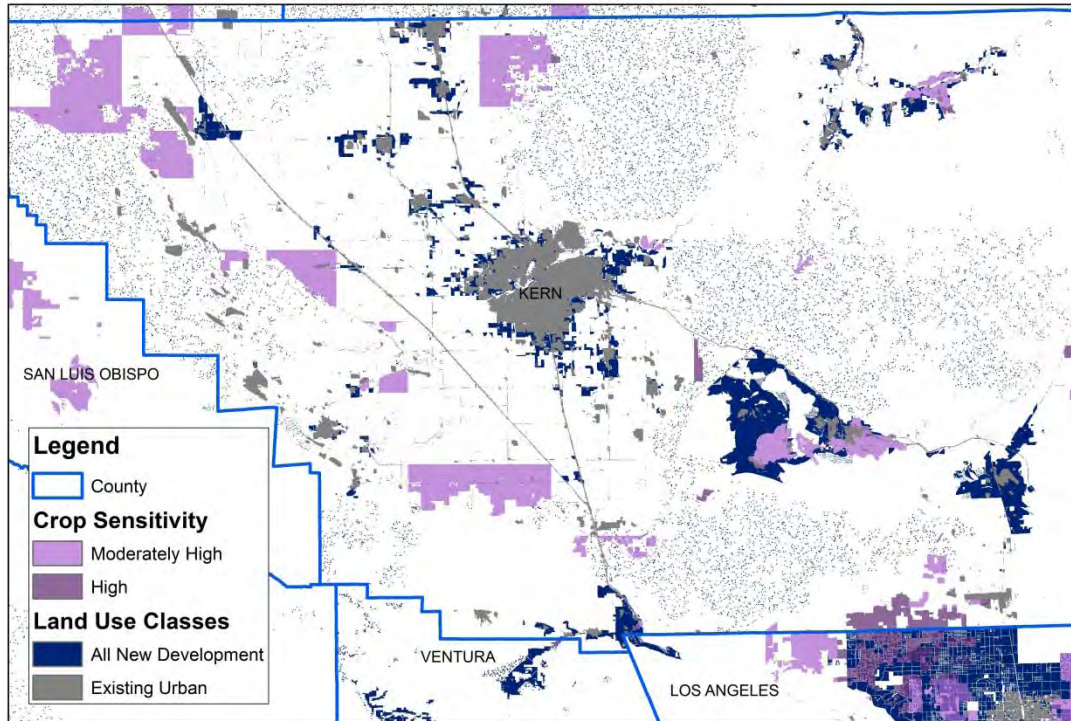

Source: Jackson et al. 2012, authors

**Figure 18: Kern County, showing the Agricultural Scenario UPlan Output and the Crop Sensitivity Areas**

Figure 18 shows Kern County and the northern areas of Ventura and Los Angeles counties. In Kern County, where there is more open space for new development, the discouragement weights successfully limit new growth in the crop sensitivity areas. In Los Angeles County, the lack of open space along with strong attraction weights counteract the discouragement weights of the crop sensitivity areas, which ultimately allow new growth to be allocated in those areas.

## Section 3: Performance of Scenarios on Additional Impact Measurements

The different scenarios can be evaluated based on their impacts to other future modeled areas, such as agricultural vulnerability, biodiversity, and wildfire probability.

### 3.1 Agricultural Vulnerability

To examine the impact of new development on agricultural vulnerability, we looked at three indices developed by Louise Jackson and others at UC Davis as part of an Agricultural Vulnerability Index (AVI) for California: Climate Vulnerability, Crop Vulnerability, and Land Use Vulnerability. These three indices were available as statewide surface layers at a 12.5 km<sup>2</sup> grid size.

Jackson and her team generated a principal component analysis (PCA) for each of the three indices examined, and each was standardized to have a mean of zero and a standard deviation of one.

### 3.1.1 Climate Vulnerability

Jackson et al. (2012) looked at exposure to a set of eight climate variables to assess agricultural vulnerability: lowest minimum temperature, days above 30°C(86°F), days in July above 35°C (95°F), days in the growing season, chill hours, precipitation, the coefficient of variation of precipitation, and potential evapotranspiration.

The final surface layer classifies climate vulnerability for agriculture based on the standard deviation of each cell value (Figure 19). The surface layer presents values related to the above-mentioned climate variables, regardless of whether the grid cell overlaps with current agricultural land. From this surface layer, we calculated the number of acres of new residential housing within each class (Figure 20).

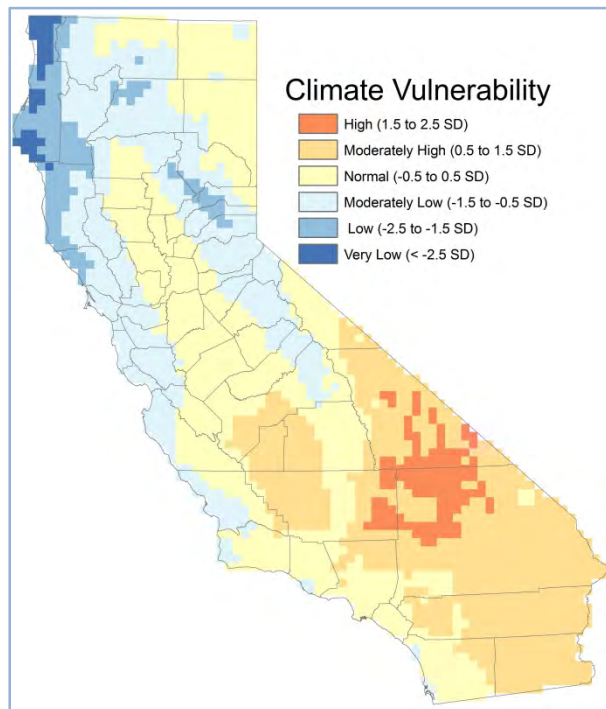

Source: Jackson et al. 2012

**Figure 19: Climate Vulnerability Surface**



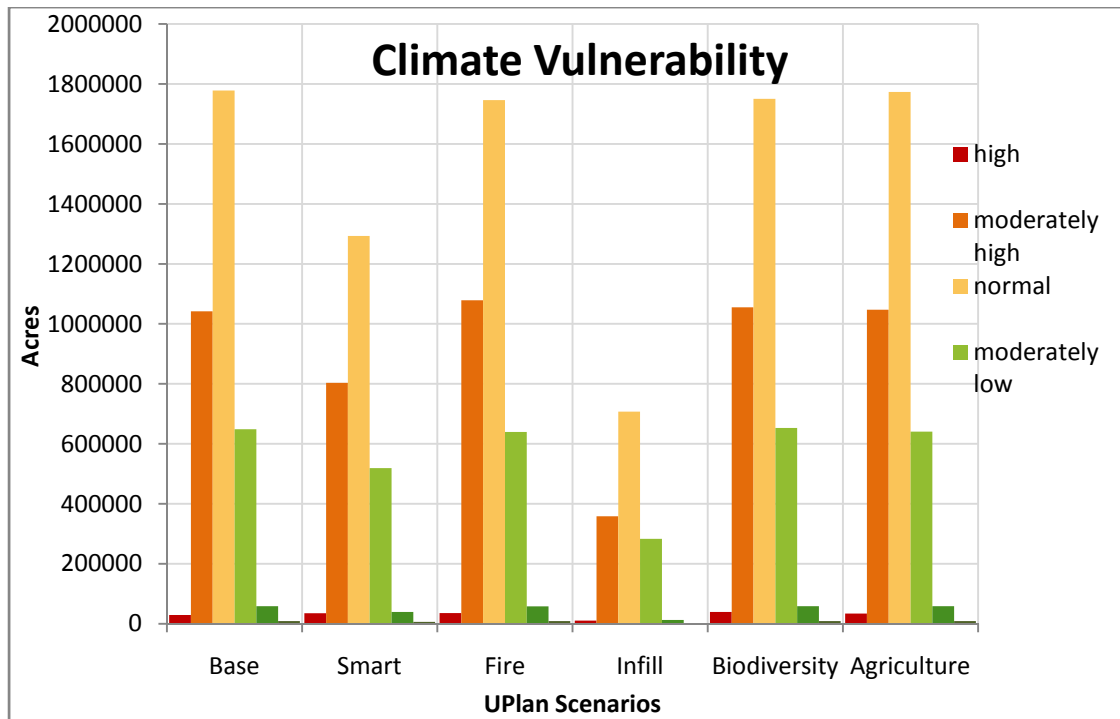

**Figure 20: The Number of Acres of New Residential Development within Each Climate Vulnerability Class**

The results from the urban growth impact measurement for climate vulnerability for agriculture show a relatively similar pattern for the Base Case, Fire Threat Avoidance, and Biodiversity scenarios, with almost equally high numbers of acres in each climate vulnerability class. The Agriculture Scenario shows little difference from these scenarios as well. This is due to the allocation by UPlan of housing to rural and low-density household types. These four scenarios all allocated the same numbers of households to the rural parts of the state; only the spatial patterns of those houses changes with scenario. The Smart Growth scenario affects fewer acres in each class and the Infill scenario fewer still. This suggests that the higher density of residential households has a greater mitigating effect on the impact of development to vulnerable areas than does differing patterns of development that essentially place the same number of buildings into rural landscapes, only in different spatial configurations.

### 3.1.2 Crop Vulnerability

Crop vulnerability was determined based on three indices: crop sensitivity, level of agrobiodiversity, and risk of crop losses from pest and disease. These maps were derived by another research group in the Climate Vulnerability and Assessment project (Jackson et al. 2012), and were incorporated with discussion from them. The crop sensitivity index presupposes that crops with a small statewide area were considered more sensitive since they could be restricted by climatic conditions, low market demand, or heavy reliance on nearby processing facilities. Crop sensitivity was measured by an index value between zero and one, where the most sensitive crops, or those with the least area, were given a one, and the least sensitive crops, or those with the most area, were given a zero. If a grid cell contained no crops, a value of zero was assigned, with the reasoning that areas with no crops pose no agricultural vulnerability. The agrobiodiversity index measures the number of different crop species within

each cell, presuming that more diversely planted areas spread risk and are more easily adaptable to climate and market changes. The index ranges from zero to one, with the most homogenous areas given a value of one and the most diverse areas a value of zero. Grid cells with no crops were again assigned a value of zero. The last index represents the risk of crop losses from pest and disease, and relied on pesticide use rates from the CAML database. The index sums the total weight of pesticides used within each grid cell and divides the sum by the total area of cropland.

The final surface layer classifies climate vulnerability based on the standard deviation of each 12.5 km<sup>2</sup> cell value (Figure 21). From this surface layer, we calculated the number of acres of new residential housing within each class (Figure 22).

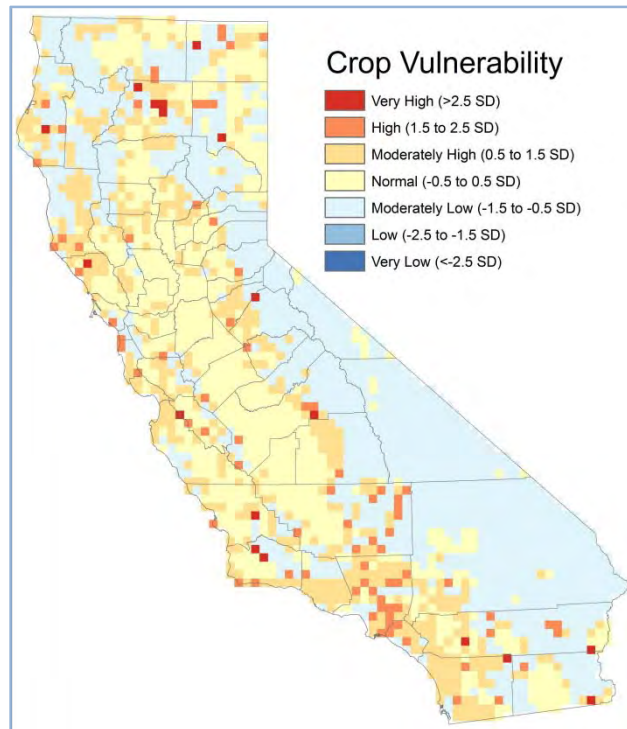

Source: Jackson et al. 2012

**Figure 21: Crop Vulnerability Surface**

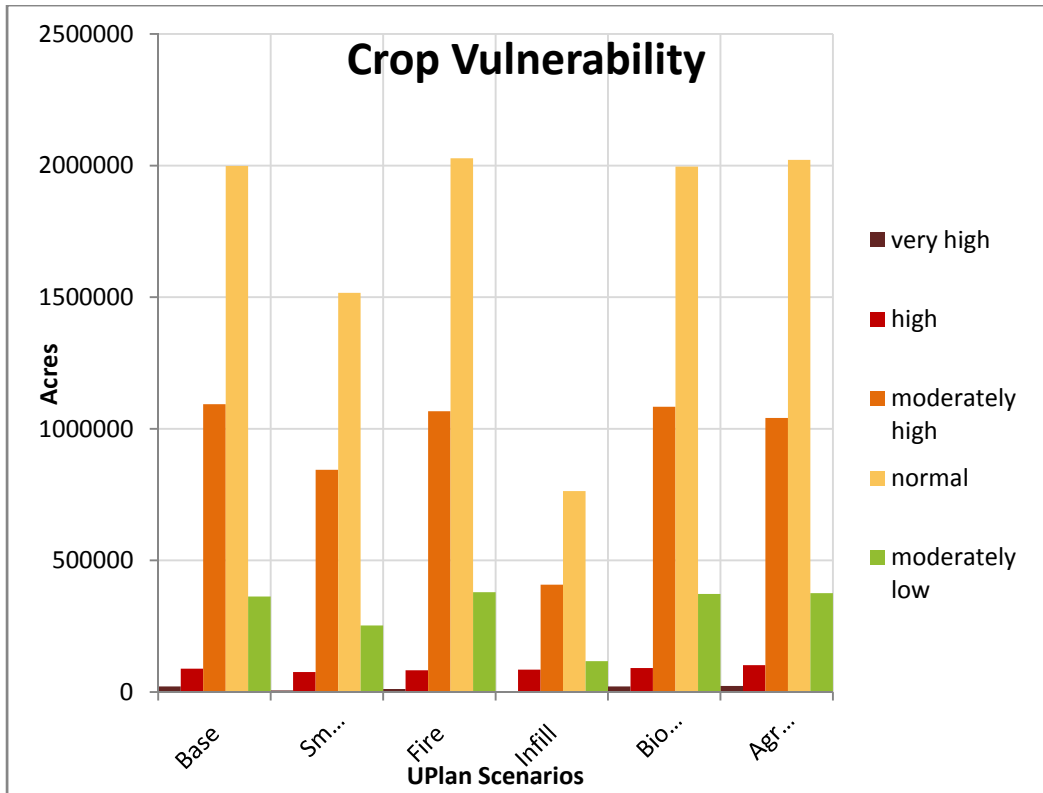

**Figure 22: The Number of Acres of New Residential Development Within Each Crop Vulnerability Class**

The initial results indicate that the Base Case, Fire Threat Avoidance, and Biodiversity scenarios consume the highest amount of land on normal and moderately low crop vulnerability grid cells. This is likely due to the lower density housing characterized in these scenarios. Additionally, the Fire Threat Avoidance scenario represents a policy that avoids development on areas of high fire threat, and therefore seemingly selects a higher amount of agricultural land for development instead. The same is most likely true for the Biodiversity scenario. The Agriculture scenario shows only a slight decrease in the amount of acreage within very high and high crop vulnerability areas. This is likely because the crop vulnerability grid was clipped by the current agriculture extent for use in the UPlan model as a discouragement to growth. When the same zonal summary is performed using the clipped crop vulnerability grid, we see a marked difference in the overlap of new growth in the Agriculture scenario with the “high” and “moderately high” vulnerable crop areas (Figure 23). This highlights the difficulty of performing impact analysis using the UPlan model run outputs, which are at a 50 m<sup>2</sup> cell size, with external model outputs at a much larger cell size. However, the scale limitation in this case is from the agricultural modeling outputs, which were constrained to the operational scale of their data (Jackson et al.2012). The integration with UPlan model outputs is still informative, but requires careful interpretation. We feel the analysis with the clipped to current cropland extent (below) is the most appropriate basis for integration with UPlan outputs.

For impacts on existing croplands, new development in the Agriculture scenario still affects highly and moderately highly sensitive lands (475,239 combined acres impact) more than the

Infill Scenario (106,186 combined acres impact). This is because urban areas abut agricultural lands in many parts of the state, and indicates that a policy of redevelopment may be more beneficial to agriculture than a policy of agricultural land protection, as that relates to climate change.

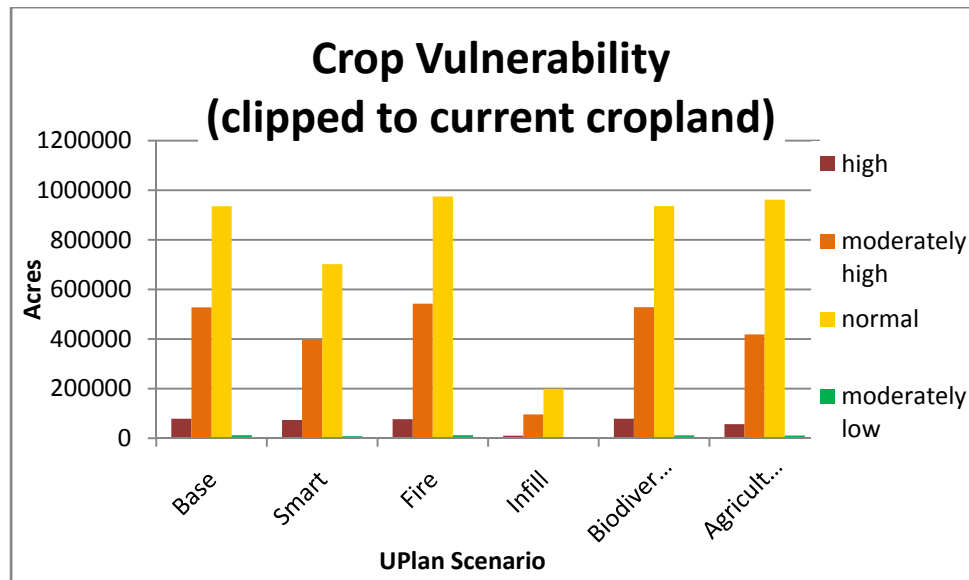
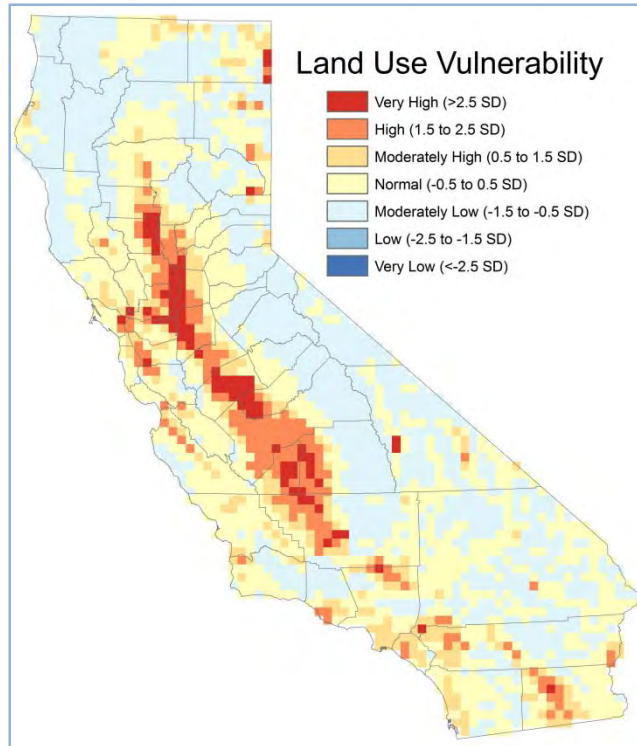

Figure 23: Zonal Summary of the Number of Acres of Residential Development in Each Scenario with the Clipped Crop Vulnerability Layer

### 3.1.3 Land Use Vulnerability

The land use vulnerability variable was generated using several indices to approximate the vulnerability of agricultural lands to the threat of urbanization and flood, as well as the quality of the farmland as a measure of potential value loss if cropland were to be converted or lost. To measure the threat of urbanization on farmland, the percent of cropland within each 12.5 km<sup>2</sup> grid cell was calculated, using the CAML dataset (Hollander 2010). Another variable was created to measure the fraction of land area converted to urban land use by cell, between 1992 and 2000, using the national Land Cover Database (NLCD) (Fry et al. 2009). The risk of flooding was assessed using a variable consisting of the fraction of land area in the 100-year floodplain for each grid cell (FEMA 2008). To measure the quality of the farmland, the weighted average of the Storie index value (a common measure of the agricultural productive capacity of a soil) was measured for each cell (Storie 1978; Beaudette and O’Geen 2009; Soil Survey Staff 2006). The soil salinity in each grid cell was also used to represent a measure of farmland quality, from a weighted average of electrical conductivity (millimhos/centimeter) from a raster version of the Soil Survey Geographic (SSURGO) soil dataset (Soil Survey Staff 2006; Beaudette and O’Geen 2009, website).

The final surface layer classifies climate vulnerability based on the standard deviation of each cell value (Figure 24). From this surface layer, we calculated the number of acres of new residential housing within each class (Figure 25).



Source: Jackson et al. 2012

**Figure 24: Land Use Vulnerability Surface**

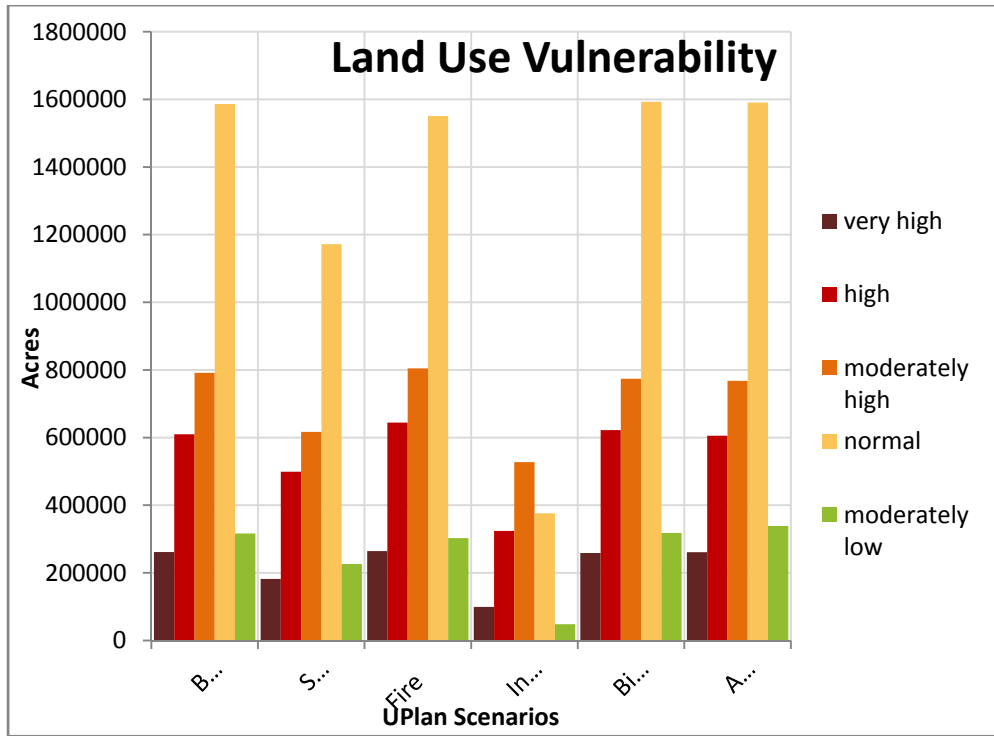

**Figure 25: The Number of Acres of New Residential Development within Each Land Use Vulnerability Class**

The pattern of impact from new development on land use vulnerability is similar to that of climate vulnerability (described in Section 3.1.1), with policy scenarios that allow more sprawl having more of an impact on vulnerable land than compact growth policy scenarios. The Agriculture Scenario shows little difference from the Base Case Scenario, but this is not surprising, as the land use vulnerability was not one of the indices that was discouraged in the Agriculture Scenario model. We did not use land use vulnerability as a discouragement because it incorporates a series of socio-economic variables that were not directly related to climate vulnerability. However, it is informative to examine the UPlan outputs relative to this layer because this map represents the overall current-time best estimate of overall agricultural vulnerability in the state. The UPlan study is supposed to focus on climate vulnerability, and hence used only the climate components of Jackson et al. (2012) to drive UPlan outputs. The Infill scenario in particular affects normal and moderately low classes of land use vulnerability far less than the other scenarios, likely because much of the growth is in already-fragmented and urbanized areas.

### 3.2 Biodiversity

As outlined in Section 2.5, Lee Hannah et al. (2012) at UC Santa Barbara examined priority areas for the conservation of native California plant species, in current and future time periods. The Network Flow Model uses current nodes of suitable habitat for plant species and adds future nodes based on species distribution maps for two climate scenario outputs, PCM A2 and GFDL A2, for 2000–2050. The Network Flow Model outputs use the value system shown in Table 14:

**Table 14: The Network Flow Model Categories**

1	Unused
2	Existing Protection
3	Developed
*4	Additional protection needed for 100 km <sup>2</sup> chains only
*5	Additional protection needed for 1000 km <sup>2</sup> chains only
*6	Additional protection needed under both chains

\*These values are used in the impact assessment and figure below.

Source: Hannah et al. 2012.

We analyzed how each of the UPlan scenario outputs affect the two Network Flow Model outputs' (PCM and GFDL) final three values, using the GIS geoprocessing zonal summaries tool. Figure 26 shows the summary of each UPlan Scenario using the number of households. There were zero households that overlapped with category 4 under PCM climate conditions, and very few that overlapped with category 4 under GFDL conditions.

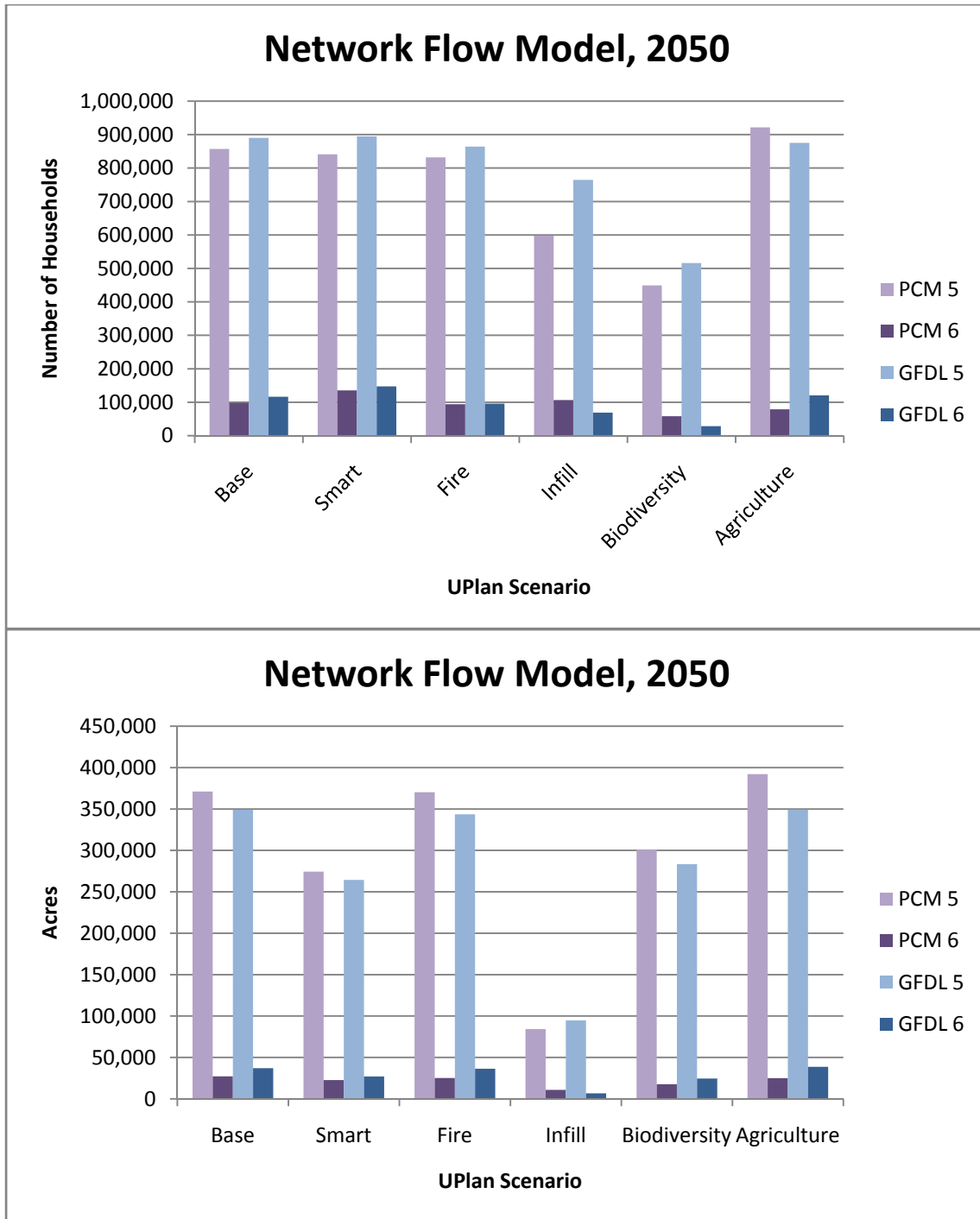

**Figure 26: The Number of Households and Acres in Each UPlan Scenario within Each Climate Scenario and Protection Value**

Not surprisingly, the Biodiversity Scenario has the fewest number of households within the conservation target areas, followed by the Infill Scenario. The three scenarios with the most low-density housing – the Base Case, Smart Growth, Fire Threat Avoidance, and Agriculture scenarios – have the highest number of households overlapping the conservation target areas.



The same pattern is observed for the number of acres from each scenario footprint that overlap with the conservation target areas (Table 15). The Agriculture scenario output has the greatest impact on four of the six Network Flow Model categories, suggesting that preserving vulnerable agricultural lands comes at a cost to certain biological conservation efforts (Figure 27). These results are similar to those found in Beardsley et al. (2009), who found that preserving high quality agricultural soils in one UPlan scenario for the San Joaquin Valley pushed growth into the Eastern foothills of the Sierra Nevada Mountains, affecting natural resources such as vernal pools and blue oak woodlands.

**Table 15: The Number of Acres of New Residential Development that Coincide with Each Network Flow Model Category for 2050**

	<b>Network Flow Model Category</b>	<b>Base Case Scenario</b>	<b>Smart Growth Scenario</b>	<b>Fire Threat Avoidance Scenario</b>	<b>Infill Scenario</b>	<b>Biodiversity Scenario</b>	<b>Agriculture Scenario</b>
<b>PCM</b>	4	0	0	0	0	0	0
	5	371,137	274,299	370,306	84,310	301,263	392,166
	6	27,113	22,741	25,163	10,779	17,731	24,942
<b>GFDL</b>	4	41	33	47	6	37	49
	5	349,029	264,314	343,556	94,696	283,432	349,220
	6	37,104	27,049	36,315	6,730	24,558	38,713

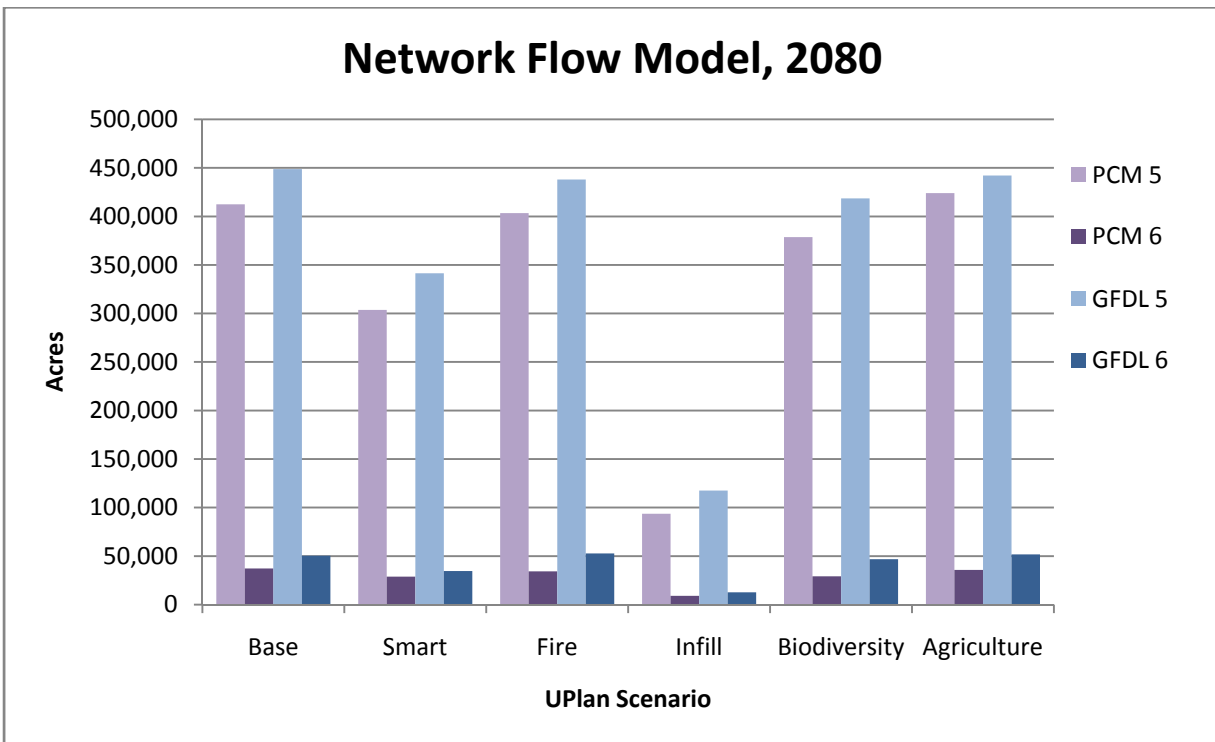
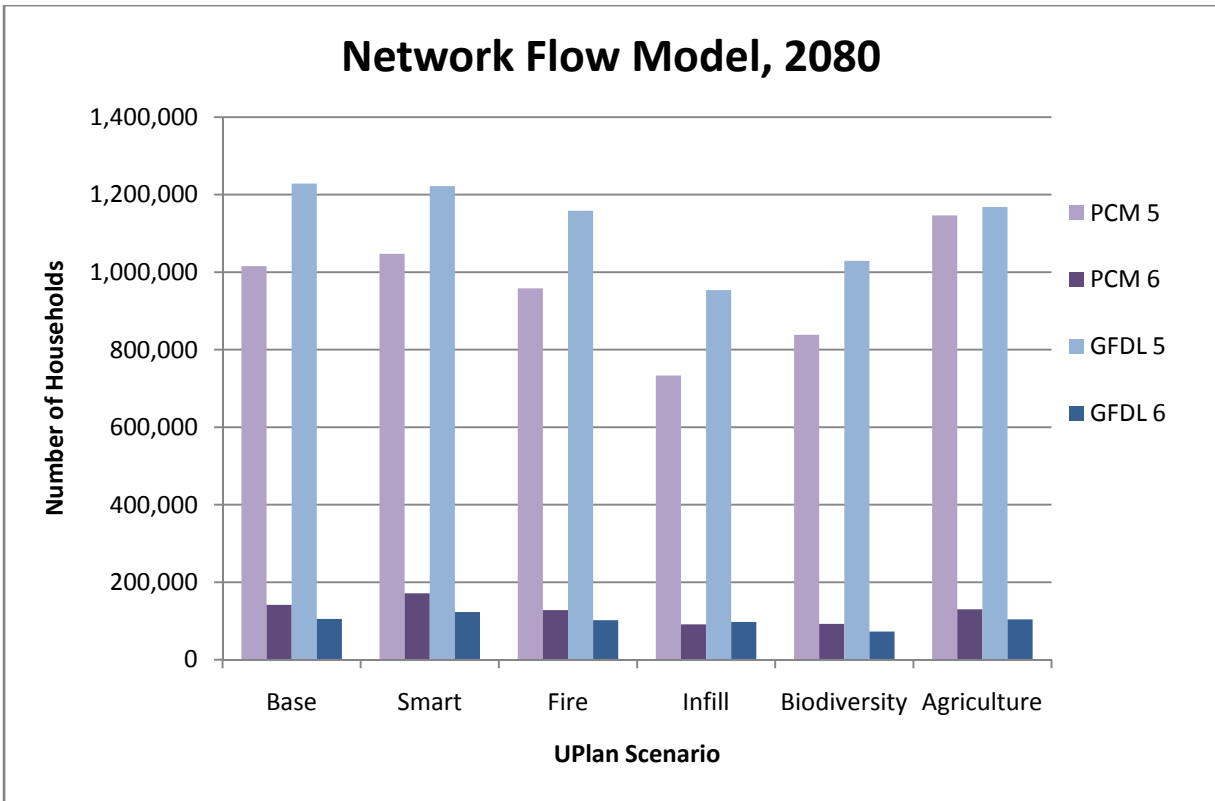

**Figure 27: The Number of Households and Acres in Each UPlan Scenario within Each Climate Scenario and Protection Value for the year 2080**

**Table 16: The Number of Acres of New Residential Development that Coincide with Each Network Flow Model Category by 2080**

	Network Flow Model Category	Base Case Scenario	Smart Growth Scenario	Fire Threat Avoidance Scenario	Infill Scenario	Biodiversity Scenario	Agriculture Scenario
<b>PCM</b>	4	5890	4383	3766	556	3310	4396
	5	412429	303584	403401	93683	378726	423956
	6	37318	28913	34306	8990	29229	35814
<b>GFDL</b>	4	3761	2667	4279	366	4561	3849
	5	448674	341390	438051	117590	418597	442077
	6	50445	34633	52786	12621	46818	51749

By comparison to the 2050 model end date, the impact of new growth on areas where additional protection is needed by 2080 is even greater (Table 16). The difference in impact is especially evident for the GFDL climate scenario. Whereas the impact under PCM climate conditions in 2050 was as great or greater than under GFDL conditions, in 2080 this seems to be reversed. This suggests that more protection area is needed for plant species under the drier, hotter conditions of the GFDL climate scenario toward the end of the century. Indeed, the number of acres of housing for the year 2050 under the Infill Scenario, the most compact of the growth scenarios, affects over 117,000 acres of protection area under the GFDL climate scenario by 2080, up 20,000 acres from the GFDL climate scenario for 2050.

### 3.3 Wildfire

#### 3.3.1 Wildfire Probability

In addition to factoring wildfire threat into our analysis with the Fire Threat Avoidance scenario, we also wanted to analyze the risks to new growth on areas predicted to have higher wildfire frequencies in the future based on climate change. Meg Krawchuk and Max Moritz at Simon Fraser University and University of California, Berkeley, examined the vulnerability of land to fire activity based on future climate conditions. We looked at one component of their study, a measure of estimated fire frequency, using a statewide surface layer of mean fire return interval (mFRI). The mFRI is the inverse of fire counts within a 30-year period, or  $30/n$ , where  $n$  is the mean expected fire event count estimated by the model (Krawchuk and Moritz2012) (Figure 28).

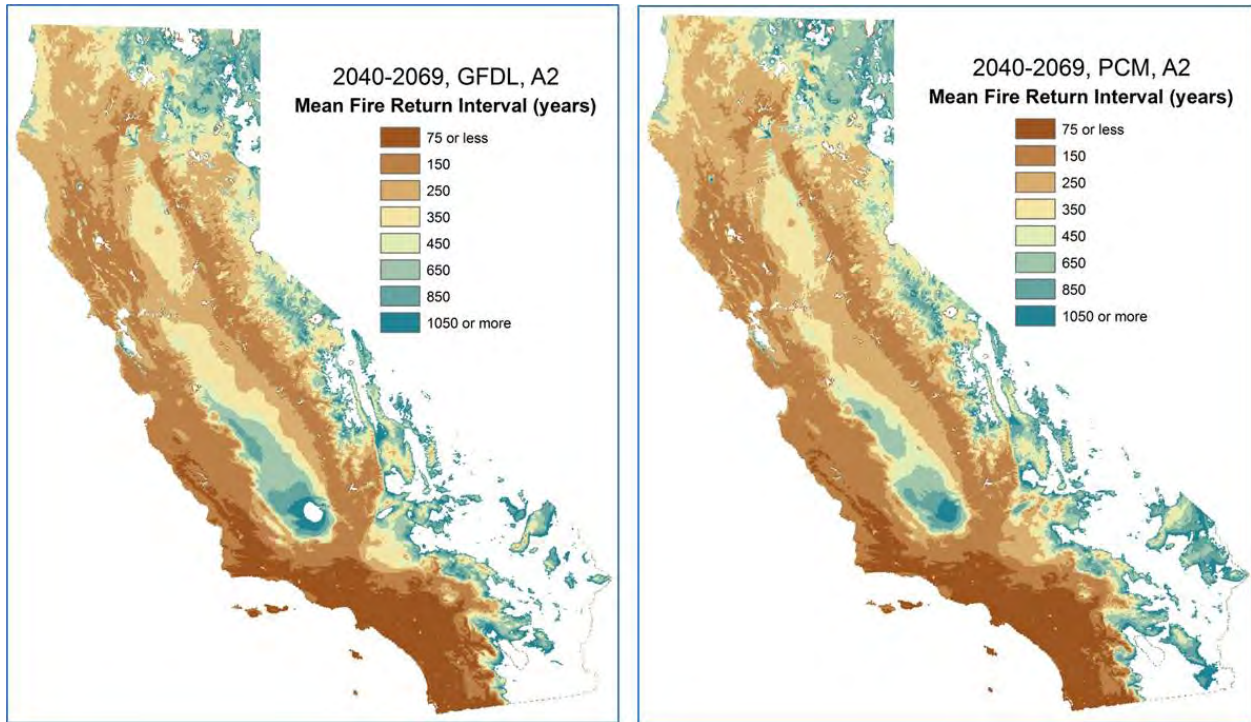

Source: Krawchuk and Moritz 2012

**Figure 28: Mean Fire Return Interval (Years). The Areas in Dark Brown Show Where Fire is Predicted to Occur at Least Once in the Next 75 Years. The Conditions of the PCM Climate Scenario Show an Overall Higher Risk for Fire in the State.**

Using these classes, the areas where a fire is predicted to occur at least once based on the Krawchuk and Moritz model within the next 75 years become visible. We considered this time interval to represent the highest increased risk (over current fire threat) to new residential growth from the UPlan scenarios.

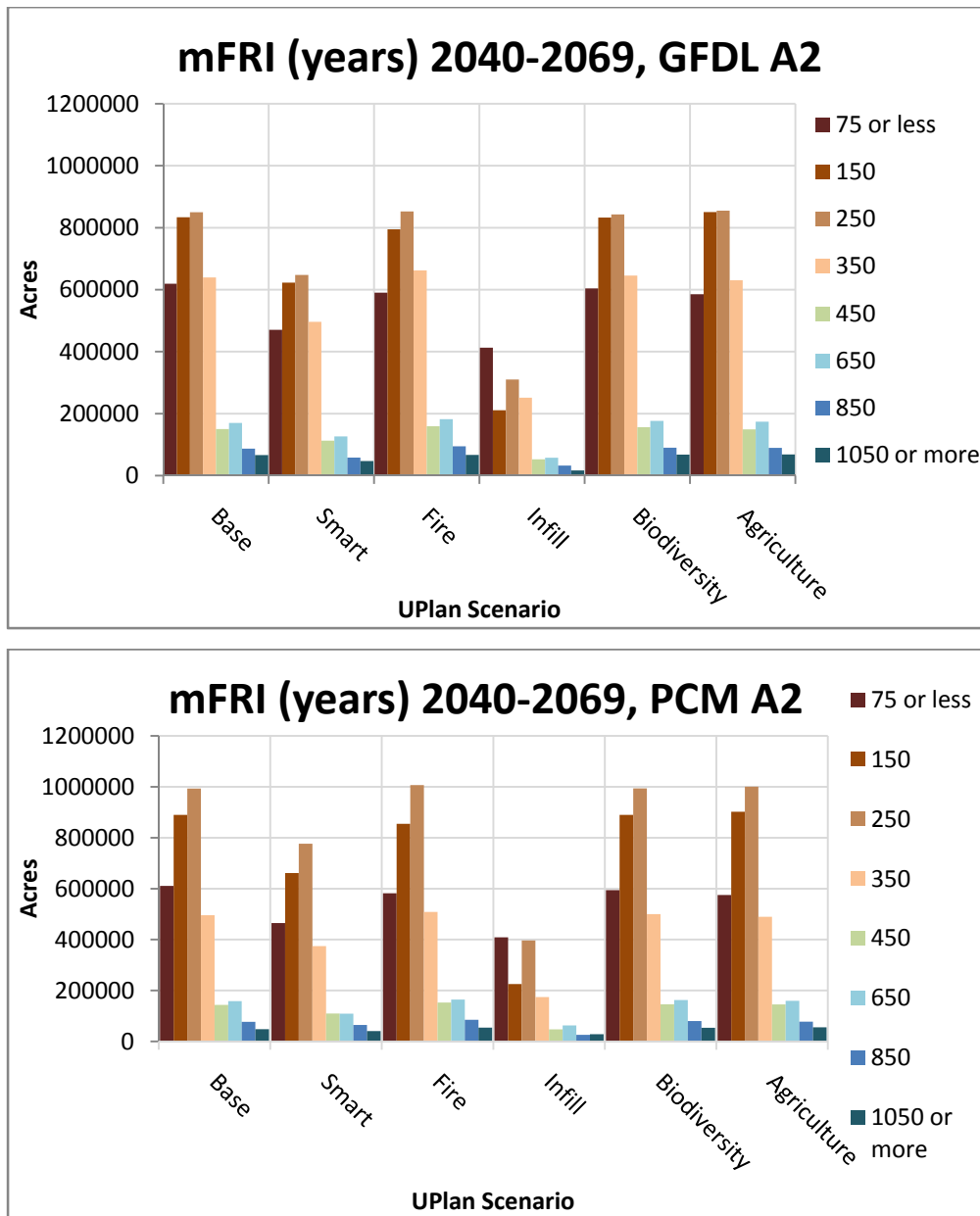

**Figure 29: The Number of Acres of New Residential Development Within Each Scenario that Coincide with Areas of Predicted Fire, Under GFDL A2 and PCM A2 Climate Conditions, 2040–2069**

In analyzing the coincidence between acres of new residential growth and the different classes of future fire projection, a similar pattern emerges, with the higher housing density scenarios having less exposure to new fire threats than the lower density scenarios (Figure 29). It is interesting that the Fire Threat Avoidance scenario (which uses current fire threat) does not show more of a decrease in overlap of new growth and more frequent fire prediction than the Smart Growth or Infill scenarios. This is likely due to the rules guiding the new growth in UPlan. The Infill and Smart Growth scenarios both cluster new development inside or much closer to existing urban areas than any of the other scenarios. The fire threat for these areas is

lower than for more remote regions. Nevertheless, we should note that the major population centers in southern California are all within the highest zone of increased fire exposure, according to the future fire models. Many urban areas in this part of the state are already in high fire risk zones, and new development from even the most compact scenarios may still be in areas of increased risk. Figure 30 shows the number of residents within each mFRI class for each scenario, and Figure 31 shows the area associated with those residents. From this perspective, the Fire Avoidance Scenario does decrease the number of residents affected in the highest mFRI class; however, the lowest number of people affected comes from the Infill scenario. And while the Infill Scenario shows the fewest number of new residents within all mFRI zones among all the other scenarios, this is somewhat deceptive for the following reason. The Infill Scenario uses a two-step approach for the model run, first running the new population from 2000–2050, and then running the model with the existing residents within the urban areas that were displaced (see Section 2.4 for further details). This additional step changes the total number of individuals modeled within the two runs. For this impact analysis on future fire threat, only the population that was modeled *outside* of urban areas was considered, since the other scenarios do not also consider residents within existing urban boundaries. Because of this reduced area, the Infill Scenario population numbers show approximately 13.5 million fewer residents than the other scenarios. These are people living or who will live within urban boundaries, and thus are not shown in the figures.

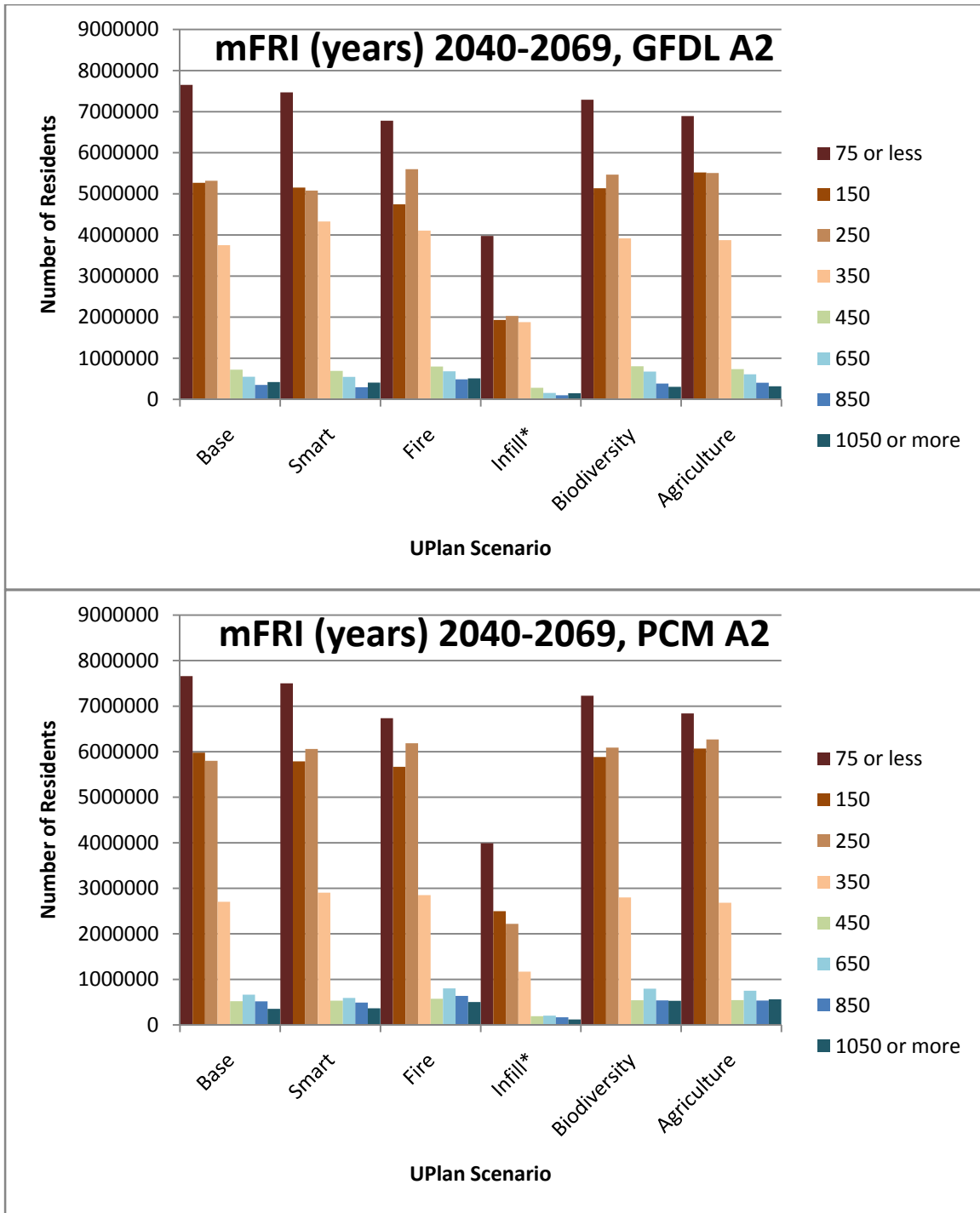

**Figure 30: The Number of New Residents by 2050 That Are Projected to Live within Each Fire Return Interval Zone**

\*The population from the Infill Scenario does not include the 13.5 million residents that live within existing urban boundaries.

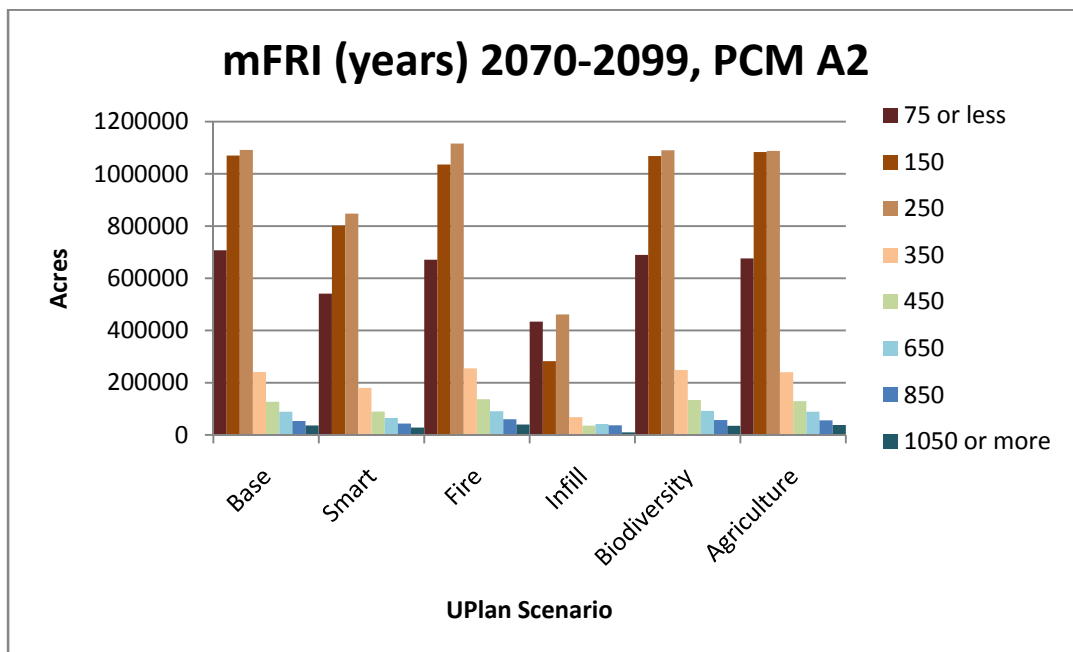
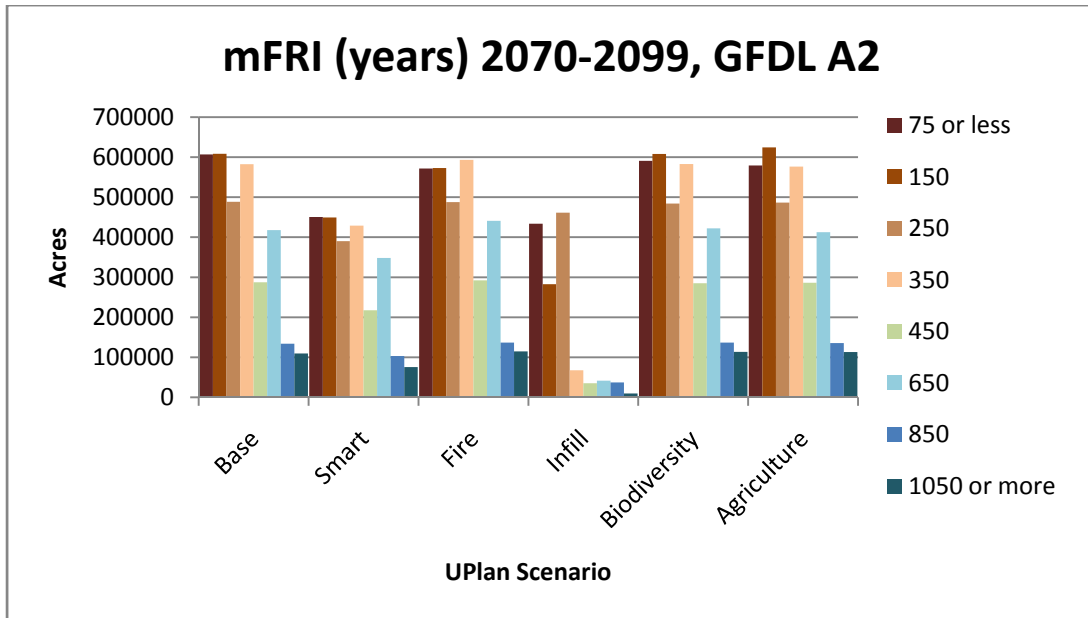

**Figure 31: The Number of Acres of New Residential Development within Each Scenario That Coincide with Areas of Predicted Fire, Under GFDL A2 and PCM A2 Climate Conditions, 2070–2099**

We can also point to the differences in cell size as a possible reason for why the Fire Threat scenario output does not show more of a decrease in overlap with the mFRI layer. When we perform the same zonal summary analysis using the FRAP Fire Threat layer, we see a marked difference in the number of acres of new development in “extreme” and “very high” fire threat areas (Figure 32). While this same layer was used within our scenario model run as a discouragement, which would also explain why new development in those areas was diminished, the FRAP layer was created at a 100 m<sup>2</sup> cell size, as opposed to the 1,080 m<sup>2</sup> cell size of the mFRI layer.



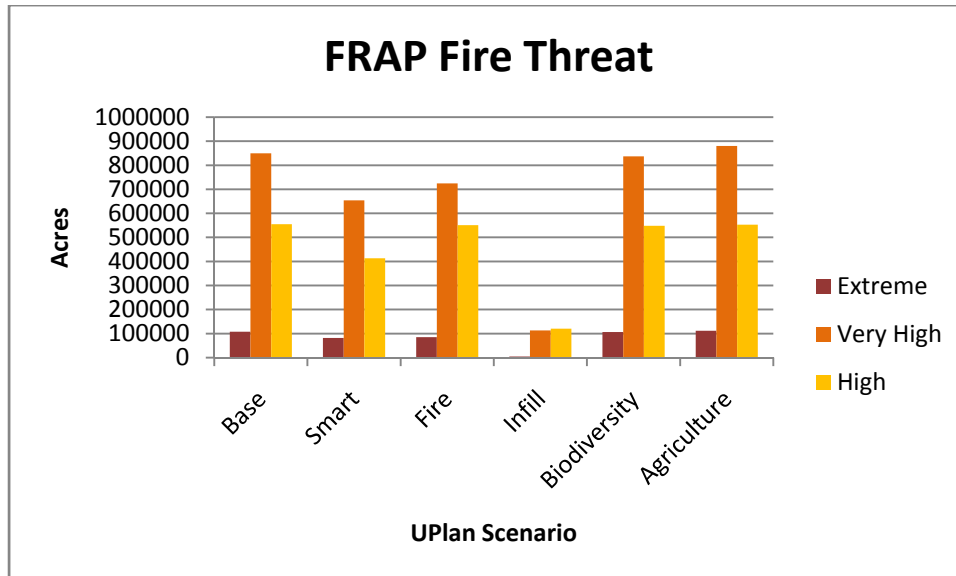

**Figure 32: Zonal Summary of the Number of Acres of Residential Development in Each Scenario with the FRAP Fire Threat Layer**

It is interesting to note, however, that by the end of the century, the pattern of overlap between new growth and areas of higher fire prediction change between the GFDL A2 and PCM A2 scenarios. For the GFDL A2 Scenario, the number of acres of overlap between the higher fire probability areas and new growth are considerably lower than for the PCM A2 Scenario. This is consistent with Krawchuk and Moritz (2012), where they conclude that the warmer and drier conditions of the GFDL General Circulation Model (GCM) has decreased vegetation and connectivity to such a degree that fire becomes less likely in those areas. In contrast, the PCM GCM predicts warmer and wetter conditions that could stimulate new growth and connectivity, increasing fire probability.

### 3.3.2 Wildfire Risk

The interaction between wildfires, climate change and population growth is also described by Benjamin Bryant and Anthony Westerling (2012), who used three of the UPlan scenario outputs and three outputs from another urban growth model, ICLUS (U.S. EPA 2010), in their study estimating fire probability and expected property loss.

Using three global climate model scenarios, two emissions and the six urban growth scenarios, Bryant and Westerling developed statistical fire models built around the relationship between human interaction with the environment and climate change-related vegetation effects, to show the future fire risk in California. Their study shows that the greatest fire risk occurs in areas outside of urban centers and agricultural areas, in places where rural housing meets vegetated areas.

The results of the study show several interesting trends relating to urban growth and UPlan in particular. First, the risk of fire increases substantially toward the end of the century, where differences between climate and land use scenarios can be more easily discerned. This suggests that UPlan outputs dating to 2100, as opposed to 2050, may show greater differences between policy scenarios or impact analysis to environmental or agricultural phenomenon.

A second observation from the wildfire risk study is that the UPlan model has fewer discrete density classes than other models, and the maps of existing urban extents have no explicit housing density classes. Because UPlan projects spatially explicit future growth, on a unit-by-unit basis, our focus has been on future housing density trends, rather than patterns in the existing housing stock. Since current time housing maps are not spatially explicit, we treat the standing stock as a single, constant layer of building densities. This differs from ICLUS, which projects housing density but not location. ICLUS therefore can make use of existing census data that permits density measures. These data would be useful to bring into the starting conditions for UPlan. However, to make consistent spatially explicit trending, we would prefer to use a map of existing buildings. This may exist, or be possible to develop for urban area, but for rural areas, which are frequently of great interest in these types of modeling exercises because of the other resources they contain that may be lost to urban growth, no suitable maps exist. It is unfortunate that we have not yet found a suitable existing urban layer that explicitly denotes household density types, especially in rural areas, and find development of such a map would be of high utility, not only as an input to UPlan. Such a map could be developed through a combination of parcel, census, and remote sensing data.

Last, this study shows that the different climate change scenarios affect fire risk differently depending on the region of the state and the coinciding growth scenario. For example, in areas with current high fire risk, such as northern California mountains and foothills, the climate scenarios with temperature-related increases tend to produce a higher probability of fire in the future. In lower elevation areas and around urban centers, however, precipitation had a greater influence on fire risk.

## Section 4: Discussion and Summary

The six UPlan scenarios represent different policies toward future urban and rural growth in California, and provide a way to measure the impacts to certain natural and human-driven phenomenon unique to California. As our environment continues to transform due to climate change, it is even more important to examine the laws and practices that govern where and how California's growing population will spread.

The Base Case Scenario represents a lack of new policy, rather than a policy itself. It not only shares the largest amount of rural sprawl with three other scenarios (Fire Threat Avoidance, Biodiversity, and Agricultural), it does not restrict or deter development from occurring in any environmentally or economically sensitive areas. It is therefore not surprising that this scenario generally affects sensitive agricultural-, biodiversity-, and fire-threatened areas the most.

The Fire Threat Avoidance, Biodiversity, and Agriculture scenarios all share the same housing density levels as the Base Case, but each one restricted growth in a particular area using model discouragements, or negative weighting based on spatial areas. This provides an interesting comparison of the overall impact of policies governing *how* people live versus *where* people live. While each scenario may offer a slight decrease in impact to the specific targeted area of the scenario, there appears to be no benefit to other impact measures. For example, the Agriculture Scenario does show a decrease in impact to the crop vulnerability index, but absolutely no benefit to areas with higher predicted wildfire probability. In fact, some areas seem to be in direct competition to each other. Preserving sensitive agricultural areas appears to come at a cost to priority areas for native plant conservation, as shown in Figure 24 and Table 12, where

more acres of new growth overlap with four of the six Biodiversity Network Flow categories than with any other scenario. Similarly, the new household development under the Agriculture Scenario impacts Extreme and Very High FRAP fire threat areas the most of all the scenarios, with more acres overlapping those areas than any other.

The Smart Growth and Infill Scenarios, on the other hand, show the effects of a policy that does not deter growth from any specific area, but rather forces growth to inhabit smaller areas by increasing housing density. While this approach does minimize the impacts to sensitive areas in a broader sense when compared to the other approach of using discouragements, there is more to the story. The Smart Growth Scenario changes the percentage of each residential class from its Base Case Scenario amount to a new amount such that the higher-density classes have a higher percentage of new households and the low-density classes will have fewer new households (see Table 7). However, the Smart Growth Scenario does nothing in the way of redevelopment or infill, so all new growth will continue to affect areas of agriculture or open space. Moreover, by bumping households from very low-density classes to slightly higher, but still low-density classes, the result may be seen by some as no better, or even worse, than the Base Case Scenario output. In many counties, the Smart Growth R1 or the 1-acre lot density class, remains almost the same as the Base Case Scenario, while R5 or the 0.2-acre lot density class decreases. Depending on general plan classifications, this can have the effect of simply changing the pattern of sprawl rather than reducing it outright. The Infill Scenario is by far the most effective scenario at reducing sprawl, and in many cases, likely increasing the densities of residential areas within existing urban areas. In all of the impact analyses, the Infill Scenario showed the least amount of overlap to sensitive areas, whether they be agricultural-, plant conservation-, or wildfire-related, in both acreage and number of households, even among the scenarios that were specifically designed to avoid such areas.

As with any model, there are improvements that can be made to UPlan, some of which were identified during the course of this project. Making UPlan iterative, so that updated transportation networks can be incorporated during the course of a run is a desirable adaptation. This could be accomplished by essentially stopping a run on a 5- or 10-year basis and updating the input layers. Another improvement would be to back cast, or start the model runs from 10–20 years in the past, which would allow comparison to actual patterns of development, a sort of calibration. This would be informative, however part of the strength of the model is that it allows a visualization of what would happen if a specific policy is followed. In many cases the actual pattern of development is affected by many things outside of policy, and the goal of this tool is not necessarily to replicate exact patterns of development, as much as to indicate what a pattern affected by a particular trend would look like. Another sensitivity analysis that could be done has to do with urban growth on the edges of counties, where the growth might spill over into another county. UPlan is somewhat constrained to place growth according to the domain, or area the model is instructed to address. One approach to dealing with this would be to run the model for regional analyses, encompassing, for example the Bay Area counties.

The UPlan model is essentially what is considered in planning a “sketch” tool. Its strengths are that it can, with a relatively low level of parameterization, represent realistically what land use patterns may appear, given a certain policy. There are a number of simplifying assumptions that are made to permit this. One assumption has to do with the actual footprint or area consumed by a given residential class. In reality, lot size varies across the range of areas

encompassed by each of our classes. To permit a rendering of the spatial pattern, we use a set, or discrete, lot size for each class. Thus, the area consumed as represented by the model may differ from the actual area used. Another assumption is that attractors and detractors are the primary drivers of where new urban growth would go. While in most cases this is likely the case, there may be places with attractions or detractors that we were not able to capture. In addition, we have not been able to identify suitable attractors for low-density rural residential classes. This may be due to the disparity in income among these residents, with some electing to build in remote locations and others near to roads; and, how lots in rural areas would be subdivided is also difficult to predict. In addition, UPlan as currently run works through the expected growth in population for the time defined, essentially an iterative, but one-step process. Built into this process, in this case for a 50-year time step, is that the policy defined would continue uninterrupted through this extent. While in reality things may change on a decade-by-decade basis, we feel that it is still informative to see what the projected influence of a policy is across a longer time period. This is both a limitation in the capacity of the modeling approach (or of any urban growth modeling approach) and a strength, in that visualization of policies can be very useful to planners who are trying to identify optimal actual growth objectives. Finally, it should be noted that UPlan is not an economic model, and also does not have an integrated travel model built into it. Adding these types of models would require a higher level of model parameterization, but would possibly make the outputs responsive to a greater variety of influences.

UPlan proved a robust modeling framework for the spatial projection and assessment of how differing public policies may affect California. The benefits of the Infill scenario are evident across all the fields considered. This leads very naturally to a guideline for planners to attempt to include infill in zoning or other local urban planning activities. In addition, expanding the modeling effort for the Infill scenario could provide valuable information for urban planners at all levels of California government. Specifically, developing a response curve that quantifies how much space may be preserved for a variety of other functions for differing numbers of people moving into Infill would be a way to inform planning efforts without getting too specific about where the infill would have to be placed, and what lands could be maintained for other purposes. For example, in Alameda County we placed ~60% of new-and-displaced-population (612,463 people) within the existing urban footprint, which required the infill/redevelopment of 49,664 acres. This is towards the goal of denser urban growth identified to us by regional planners. However, it would be informative for their efforts if other levels of infill and land use required could be identified.

Additional next steps involve developing better maps of the locations of existing housing units in current time. Particularly for rural areas, the specific locations of structures are not currently mapped. Developing robust maps of this information would allow much better assessment of how future development will impact and interact with a variety of California's resources. Planners can use the numbers of structures identified by various scenarios to project energy consumption under current and future conditions. Water consumption per residence is also a measure that could be calculated, given water consumption numbers. Finally, linking the UPlan model outputs to a travel demand model would allow for better projections of energy consumption needs under various future policy scenarios, by combining projected energy needs for the housing and transportation sectors.

## References

- Alig, R. J., J.D. Kline, and M. Lichtenstein. 2003. "Urbanization on the US landscape: Looking ahead in the 21st century." *Landscape and Urban Planning* 69: 219–234.
- Beardsley, K., J. H. Thorne, N. E. Roth, S. Gao, and M. C. McCoy. 2009. "Assessing the influence of rapid urban growth and regional policies on biological resources." *Landscape and Urban Planning* 93: 172–183.
- Beaudette, D.E., and A.T. O'Geen. 2009. "Soil-Web: An online soil survey for California, Arizona, and Nevada." *Computers & Computers* 35:2119–2128. <http://casoilresource.lawr.ucdavis.edu/drupal/node/902>.
- Befort, W.A., A.E. Luloff, and M. Morrone. 1988 "Rural land use and demographic change in a rapidly urbanizing environment." *Landscape and Urban Planning* 16: 345–356.
- Bloomberg, M. R., and A. M. Burden. 2011. *NYC Zoning Handbook, 2011*. Zoning Resolution of the City of New York, Department of City Planning.
- Bryant, B. P., and A. L. Westerling. 2012. Scenarios to Evaluate Long-Term Wildfire Risk in California: New Methods for Considering Links Between Changing Demography, Land Use and Climate. California Energy Commission. CEC-500-2012-030.
- California Department of Fish and Game. No date. California Natural Diversity Database (CNDDDB). Downloaded September, 2010.
- Calthorpe 2009. Unpublished data on transit stops. Calthorpe Associates, Berkeley, California.
- Department of Conservation (DOC) and the California Department of Forestry and Fire Protection (CAL FIRE). 2007. County Boundaries (1:24K). [http://projects.atlas.ca.gov/frs/?group\\_id=41](http://projects.atlas.ca.gov/frs/?group_id=41).
- Esri. 2005. Tele Atlas North America, Inc. Esri Data & Maps. Redlands, California: Environmental Systems Research Institute.
- Federal Emergency Management Agency (FEMA) Q3 digital flood Zones, downloaded 2008. Washington, D.C. <http://www.fema.gov/hazard/map/q3.shtm>.
- Foreman, R.T.T. 2008. *Urban Regions: Ecology and Planning Beyond the City*. Cambridge University Press: New York.
- FRAP (California Department of Forestry and Fire Protection). 2002. Methods for development of habitat data: Forest and range 2002 assessment. Technical working paper 8-19-02.
- FRAP (California Department of Forestry and Fire Protection). 2004. Fire Threat Statewide GIS layer (<http://frap.cdf.ca.gov>).
- Fry, J.A., M.J. Coan, C.G. Homer, D.K. Meyer, and J.D. Wickham. 2009. *Completion of the National Land Cover Database (NLCD) 1992–2001 Land cover change retrofit product*. U.S. Geological Survey Open-File Report 2008(1379), 18.

- GreenInfo Network. California's Protected Areas Database (CPAD). 2010. <http://projects.atlas.ca.gov/projects/cpad>.
- Hannah, L., M. R. Shaw, P. R. Roehrdanz, M. Ikegami, O. Soong, J. MacKenzie, and J. Thorne (University of California, Santa Barbara and University of California, Davis). 2012. *Consequences of Climate Change for Native Plants and Conservation*. California Energy Commission. CEC-500-2012-024.
- Herold, M., H. Couclelis, K.C. Clarke. 2003. "The role of spatial metrics in the analysis and modeling of urban land use change." *Computers, Environment and Urban Systems* 29: 369–399.
- Holland, R. F. Central Valley Vernal Pool Complexes. U.S. Fish and Wildlife Service, 2005 (revised 2009). California Department of Fish and Game. [ftp://ftp.dfg.ca.gov/BDB/GIS/Wetlands/Central\\_Valley\\_Vernal\\_Pool\\_Complexes/](ftp://ftp.dfg.ca.gov/BDB/GIS/Wetlands/Central_Valley_Vernal_Pool_Complexes/).
- Hollander, A. D. 2010. California Augmented Multisource Landcover Map, Information Center for the Environment, University of California, Davis, California. <http://cain.ice.ucdavis.edu/caml>.
- Jackson, L.E., V. R. Haden, S. M. Wheeler, A. D. Hollander, J. Pearlman, T. O'Geen, V. K. Mehta, V. Clark, J. Williams, and A. Thrupp (University of California, Davis). 2012. *Vulnerability and Adaptation of Agriculture to Climate Change in California*. California Energy Commission. CEC-500-2012-031.
- Johnston, R.A., D.R. Shabazian, and S. Gao. 2003. "UPlan, a Versatile Urban Growth Model for Transportation Planning." *Transportation Research Record* 1831: 202–209.
- Johnston, R.A., N. Roth, and J. Bjorkman. 2009. "Adapting Travel Models and Urban Models to Forecast Greenhouse Gases in California." *Transportation Research Record* 2133: 23–32.
- Krawchuk, M.A., and M. A. Moritz (Simon Fraser University; University of California, Berkeley). 2012. *Fire and Climate Change in California: Changes in the Distribution and Frequency of Fire in Climates of the Future and Recent Past (1911–2099)*. California Energy Commission. CEC-500-2012-026.
- LaGro, J.A., and S.D. DeGloria. 1992. "Land use dynamics within an urbanizing non-metropolitan county in New York State (USA)." *Landscape Ecology* 7: 275–289.
- Nelson, A.C. 2004. *Toward A New Metropolis: The Opportunity to Rebuild America*, Discussion Paper. Metropolitan Policy Program, Brookings Institution.
- Soil survey Staff. 2006. Soil Survey Geographic (SSURGO) Database for California. Natural Resources Conservation Service, United States Department of Agriculture, Washington, D.C. <http://soildatamart.nrcs.usda.gov>.
- Storie, R.E. 1978. *Storie Index Soil Rating*. Division of Agricultural Sciences. University of California. Special publication 3203.
- U.S. Census Bureau; Census 2000, Special Tabulation Request. Washington, D.C.
- U.S. Census Bureau; Census 2010. *Census Transportation Planning Products*. Washington, D.C.
- U.S. Census Bureau; 2000. *Census Transportation Planning Products*. Washington, D.C.

- U.S. EPA. 2010. ICLUS Tools and Datasets. U.S. Environmental Protection Agency, Washington, D.C., EPA/600/R-09/143F.
- U.S. Energy Information Administration. 2003 *Commercial Buildings Energy Consumption Survey*. Revised June 2006.
- U.S. Fish and Wildlife Service. downloaded January 2010. National Wetlands Inventory.. <http://www.fws.gov/wetlands/Data/DataDownload.html>.
- USGS. 2011. National Hydrography Dataset. U.S. Geological Survey, Washington, D.C. <http://nhd.usgs.gov/>.
- White, E.M., A.T. Morzillo, and R.J. Alig. 2009. "Past and projected rural land conversion in the US at state, regional and national levels." *Landscape and Urban Planning* 89: 37–48.

## Glossary

CAML	California Augmented Multisource Landcover Map
CPAD	California's Protected Areas Database
CTPP	Census Transportation Planning Products
FEMA	Federal Emergency Management Agency
FMMP	California Department of Conservation Farmland Mapping and Monitoring Program
FRAP	California Department of Forestry and Fire Protection
GCM	General Circulation Model
GFDL	Geophysical Fluid Dynamics Laboratory
NLCD	National Land Cover Dataset
PCM	Parallel Climate Model
PIER	Public Interest Energy Research
PPHH	Persons per Household
PPIC	Public Policy Institute of California
SSURGO	Soil Survey Geographic (soil maps)
TAZ	Traffic Analysis Zone
UPlan	A model for new urban growth
USGS	U.S. Geological Survey
V&A	Vulnerability and Adaption

## Appendix A: Conversion Formulas in UPlan

---

- Population Increment = Population in Projection Year – Population in Base Year
- Total Household Increment = Population Increment / persons per household
- Total Employment Increment = Total Household Increment \* Employees per household
- Industry Employment = Total Employment Increment \* (Percent employment ratio in industry/100)
- Acres for industry = Industry Employment \* (sq. ft. per employee in industry/industry FAR)
- High Density Commercial Employment = Total Employment Increment \* (Percent employment ratio in high density commercial /100)
- Acres for High Density Commercial = High Density Commercial Employment \* (sq. ft. per employee in High Density Commercial / High Density Commercial FAR)/43560
- Low Density Commercial Employment = Total Employment Increment \* (Percent employment ratio in low density commercial /100)
- Acres for Low Density Commercial = Low Density Commercial Employment \* (sq. ft. per employee in Low Density Commercial / Low Density Commercial FAR)/43560
- Households in high density residential = Total households \* (percent households in high density residential/100)
- Households in medium density residential = Total households \* (percent households in medium density residential/100)
- Households in low density residential = Total households \* (percent households in low density residential/100)
- Households in very low density residential = Total households \* (percent households in very low density residential/100)
- Acres for high density residential = Number of households in high density residential \* average lot size per household in high density residential
- Acres for medium density residential = Number of households in medium density residential \* average lot size per household in medium density residential
- Acres for low density residential = Number of households in low density residential \* average lot size per household in low density residential
- Acres for very low density residential = Number of households in very low density residential \* average lot size per household in very low density residential



## **Appendix B: Demographic Inputs for UPlan Runs**

See the attached spreadsheet for the data inputs to the model for each county. Each worksheet represents a different scenario.

## **Appendix C: CTPP to UPlan Employment Classes Crosswalk**

See the attached spreadsheet for the Census Transportation Planning Package (CTPP) 2000 employment numbers by employment type for each county. The CTPP classes are also crosswalked to the UPlan employment types.

## **Appendix D: UPlan Model GIS Layers and Weights for Attractions, Discouragements, and Masks**

See the attached spreadsheet for the Attraction, Discouragement, and Mask GIS layers used for each scenario, as well as the weights and buffers (if used) for each layer.

## **Appendix E: Infill Scenario Zonal Summaries by County**

See the attached spreadsheet for the household totals within existing urban extents, as well as the displaced population and employees from U.S. Census 2000 blocks, from Run 1 of the scenario.